

3-Way Flow Regulator, Pressure Compensated, Modular

VSS1-306

Size 06 (D03) • Q_{max} 16 l/min (4 GPM) • p_{max} 320 bar (4600 PSI)

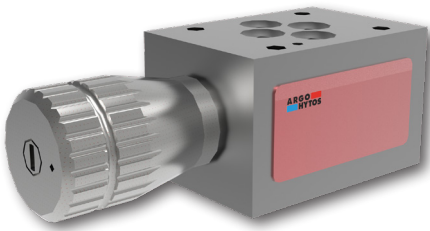

Symbol

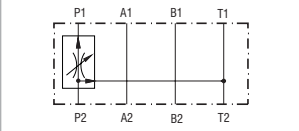

Technical Features

- › Subplate mounting interface acc. to ISO 4401, DIN 24340 (CETOP 03) for use in vertical stacking assemblies
- › Set flow rate independent of load pressure and temperature changes
- › Meter-in flow control
- › Adjusted flow rate depends on the orifice area and adjusted differential pressure
- › Quiet and modulated response to load changes
- › Adjustable by metallic hand screw
- › Fine low-torque adjustment
- › In the standard version, the sandwich plate of valve is phosphated for basic surface corrosion protection and as preparation for painting. Steel parts are zinc-coated for corrosion protection 240 h in NSS acc. to ISO 9227.
- › Enhanced surface protection for mobile applications is available. The sandwich plate and steel parts are zinc-coated with corrosion protection 520 h in NSS

Functional Description

3-Way pressure compensated flow control valves are designed to provide adjustable, controlled flow rates independently of changes in system pressure. The priority flow supplies the consumer port and excessive flow returns to the tank port.

The flow control valve consists of a housing, a throttling spool, a pressure compensator, an internal spring and a hand screw to adjust the flow setting.

Technical Data

Valve size		06 (D03)	
Max. flow	l/min (GPM)	16 (4)	
Max. operating pressure	bar (PSI)	320 (4640)	
Nominal flow rates	l/min (GPM)	16 (4.2)	20 (5.3)
Min. flow rates	cm ³ (inch ³)/min	60+10 (3.7+0.6) *	
Fluid temperature range (NBR)	°C (°F)	-30 ... +100 (-22 ... +212)	
Fluid temperature range (FPM)	°C (°F)	-20 ... +120 (-4 ... +248)	
Maximum degree of fluid contamination	for $Q \leq (1 \text{ l/min})$ for $Q > (1 \text{ l/min})$	Class 20/17/14 according to ISO 4406 Class 21/18/15 according to ISO 4406	
Max. flow rate variation at pressure change (for $Q > 2.5 Q_{min}$ and $p = 6 \dots 100\% p_{max}$)	%	± 10	
Weight	kg (lbs)	0.8 (1.76)	

* Pressure compensation is effective in the flow range $Q \geq 2 \text{ l/min}$ (0.5 GPM)

	Datasheet	Type
General information	GI_0060	Products and operating conditions
Mounting interface	SMT_0019	ISO 4401-03-02-0-05 DIN 24340 (CETOP 03)
Spare parts	SP_8010	

ISO 4401-03-02-0-05

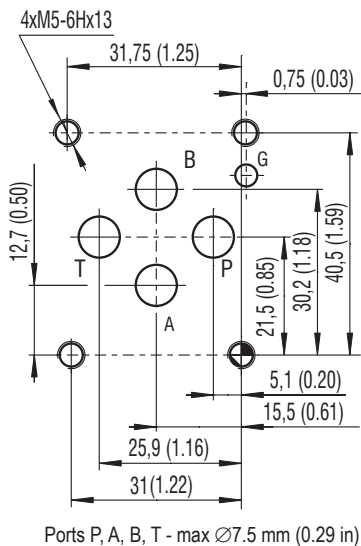

Characteristics measured at $v = 32 \text{ mm}^2/\text{s}$ (156 SUS)

Regulated flow related to input pressure

Flow direction P2 - P1

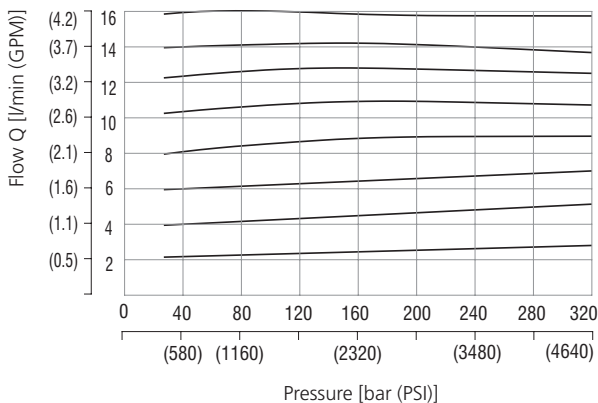

Flow rate related to indicated scale

Flow direction P2 - P1

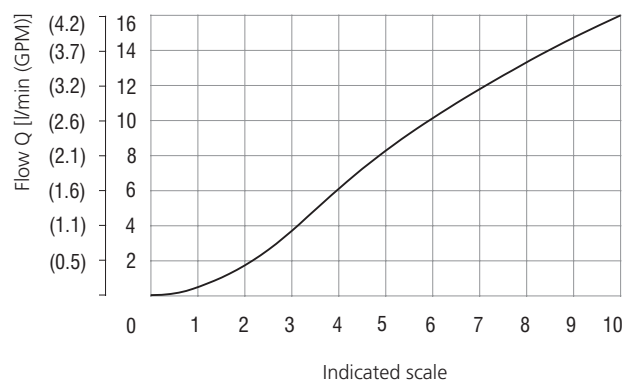

Dimensions in millimeters (inches)

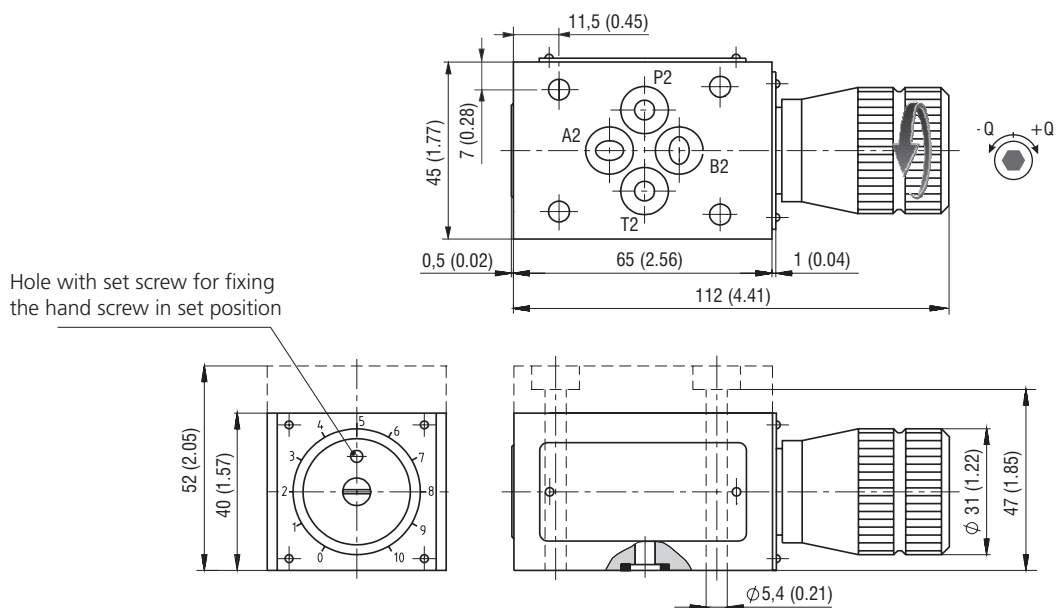

Functional symbols

Functional symbol of the valve

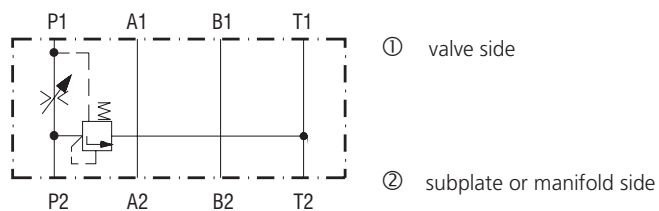

Typical application of the valve in stacking assembly*

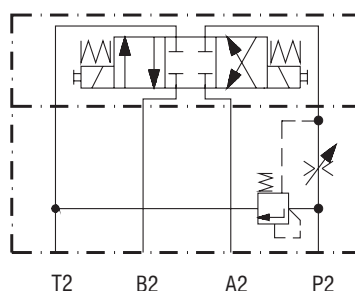

* Directional valve must be ordered separately.

Ordering Code

VSS1-3 06 - [] 11 RS [] - []		
3-Way flow regulator, pressure compensated, modular		Surface treatment No designation body phosphated, steel parts A zinc-coated (ZnCr-3), ISO 9227 (240 h) B zinc-coated (ZnNi), ISO 9227 (520 h)
Valve size		Seals No designation V NBR FPM (Viton)
Flow rate 16 l/min (4.2 GPM) 20 l/min (5.3 GPM)	16 20	Adjustment option hand screw, metal
Model sandwich plate - without blanking plate		