

Screw-in Cartridge Proportional Flow Control Valve

SF32P-C3/H

1-1/16-12 UN • inlet Q_{max} 100 l/min (26 GPM) / regulated Q_{max} 60 l/min (16 GPM) • p_{max} 350 bar (5100 PSI)

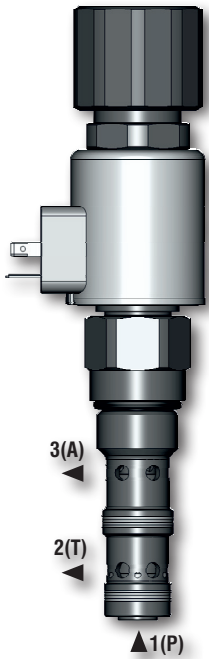

Technical Features

- › Proportional flow control operated by solenoid, realized by smooth regulation of flow cross section
- › Possible remote flow control by electric command signal
- › Pressure drop stabilisation with 3-way pressure compensator
- › Regulated volumetric flow independent of load change on an actuator and input pressure fluctuation
- › A and T may be fully pressurized up to 350 bar
- › The 3-way pressure compensator can be changed into 2-way compensator by closing port 2 in the block
- › Three types of connector for electric supply of coils available
- › Additional protection of electronic control unit by incorporating a quenching diode into the connector
- › Manual opening of throttle spool by manual override
- › In the standard version, the valve is zinc-coated for 520 h protection acc. to ISO 9227

Functional Description

Screw-in cartridge proportional flow control valve with 3-way pressure compensator. The valve is designed to control the speed hydraulic cylinder or hydraulic motor in applications where minimal speed as load or pump supply pressures change. When port 2 is connected to tank, the valve acts as a bypass and the excess fluid is discharged through port 2 back to the tank. Proportional flow control operated by solenoid, is realized by smooth regulation of flow cross section. The flow rate smoothly increases with the increasing command signal, current flowing through the coil winding.

When the port 2 is closed, the valve changes its function into flow control valve with 2-way pressure compensator and the pressure drop is controlled by fluid flow throttling at the edge of compensator spool.

Under the condition that the bypass port (2T) is open, the maximum input flow 100 l/min (26.4 GPM) from the pump (1P) is divided into the maximum regulated flow 60 l/min (15.9 GPM) to the actuator (3A) and the flow 40 l/min (10.6 GPM) into the tank (2T).

An electronic control unit (ECU) EL7 is used for the valve control. The ECU converts the input command signal into an output current control PWM signal for solenoid coils. The ECU EL7 is available as external for connection to the DIN rail (EL7-E, see datasheet HA 9152) or integrated on the valve in the form of connector plug (EL7-I, see datasheet HA 9151).

Technical Data

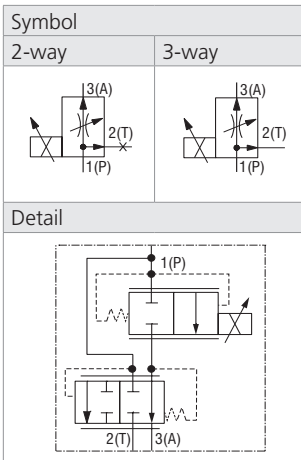

Valve size / Cartridge cavity		1-1/16-12 UN-2A / C3 (VC12-2)	
Max. inlet flow (port 1)	l/min (GPM)	100 (26.4)	
Regulated flow	l/min (GPM)	0 ... 60 (0 ... 15.9)	
Max. operating pressure in all ports	bar (PSI)	350 (5080)	
Fluid temperature range (NBR)	°C (°F)	-30 ... +80 (-22 ... +176)	
Fluid temperature range (FPM)	°C (°F)	-20 ... +80 (-4 ... +176)	
Ambient temperature range	°C (°F)	-30 ... +80 (-22 ... +176)	
Hysteresis	%	< 8	
Weight	kg (lbs)	1.17 (2.58)	
Solenoid data			
Supply voltage	V	12 DC	24 DC
Limit current	A	2.6	1.0
Rated resistance at 20 °C (68 °F)	Ω	2.33	13.1
Duty cycle	%	100	
Optimal PWM frequency	Hz	120	
Quenching diode		BZW06-19B	BZW06-33B
Enclosure type acc. to EN 60529**		IP65 / IP67 / IP69K	
		Datasheet	Type
General information		GI_0060	Product and operating conditions
Coil types		C 8007	C22B
Valve bodies	In-line mounted	SB_0018	SB-C3*
	Sandwich mounted	SB-04(06)_0028	SB-*C3* (only for size 10)
Cavity details / Form tools		SMT_0019	SMT-C3*
Spare parts		SP_8010	
Compatible control unit		EL7-E*	

**The indicated IP protection level is only reached with a properly mounted connector.

Characteristics measured at $v = 32 \text{ mm}^2/\text{s}$ (156 SUS)

Regulated flow at port A related to control signal

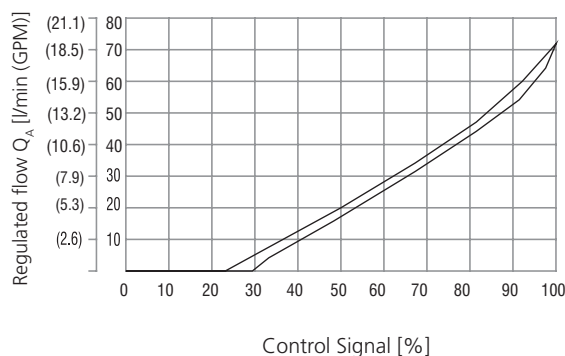

Pressure drop $\Delta p - P \rightarrow T$, 0% of control current

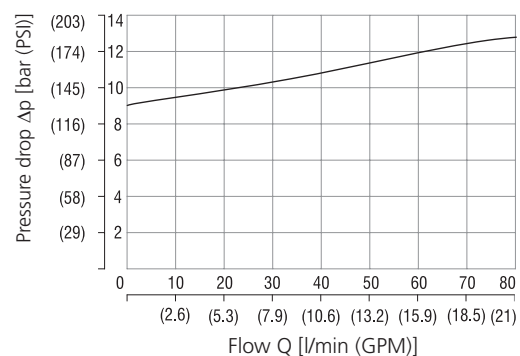

Characteristics measured at $v = 32 \text{ mm}^2/\text{s}$ (156 SUS)

Regulated flow at port A - related to load pressure
2-way pressure compensator (port T to the tank is closed)

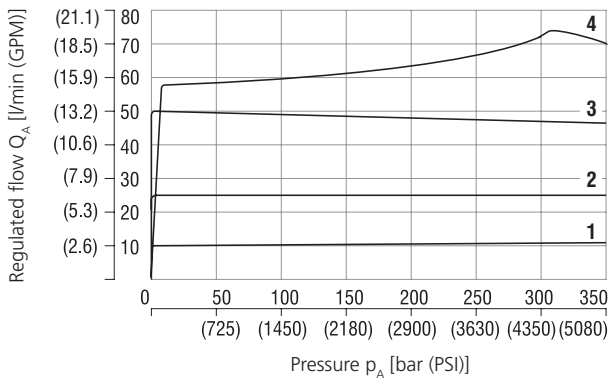

Current control signal	1	2	3	4
	40 %	60 %	80 %	100 %

Regulated flow at port A - related to load pressure
3-way pressure compensator (port T to the tank is open)

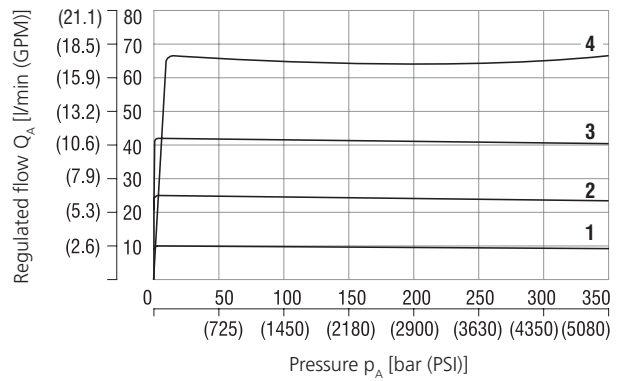

Current control signal	1	2	3	4
	40 %	60 %	80 %	100 %

Dimensions in millimeters (inches)

Type of the coil connector

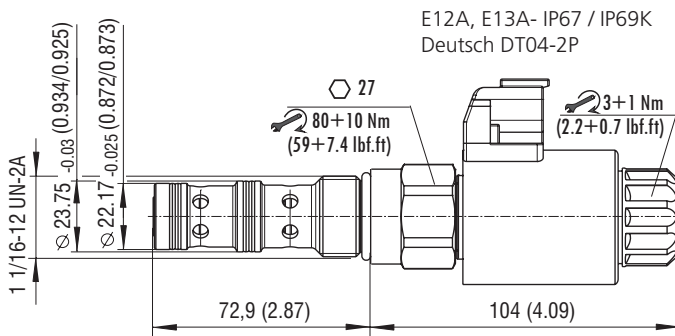

E12A, E13A- IP67 / IP69K
Deutsch DT04-2P

E1, E2 - IP65
EN 175301-803-A

E3A, E4A - IP67
AMP Junior Timer
- axial direction

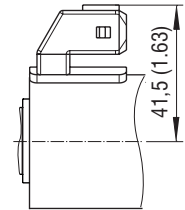
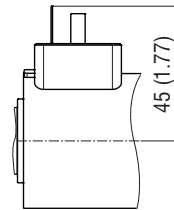

Manual Override in millimeters (inches)

M9 - without manual override

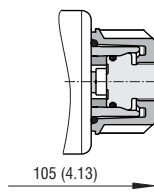

Designation M10 - red anodized swivel handle with scale

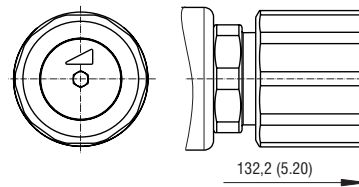

applicable up to max pressure 350 bar in the port P

Ordering Code

SF32P-C3/HC 60 - [] [] [] [] - B

Screw-in Cartridge Proportional Flow Control Valve

Valve cavity
1-1/16-12 UN (VC12-2)

Model
High performance

Functional symbol
Normally closed

Regulated flow
0 ... 60 l/min (0 ... 15.9 GPM)

Supply voltage* / limit current
12 V DC / 2.6 A **12**
24 V DC / 1.0 A **24**

Surface treatment
zinc-coated (ZnNi), ISO 9227 (520 h)

Seals
NBR
FPM (Viton)

Manual override
without manual override
swivel handle with the scale

Connector
EN 175301-803-A
E1 with quenching diode
E2
E3A AMP Junior Timer - axial direction (2 pins; male)
E4A E3A with quenching diode
E12A Deutsch DT04-2P - axial direction
E13A E12A with quenching diode

*For other supply voltages of coils see data sheet C_8007.