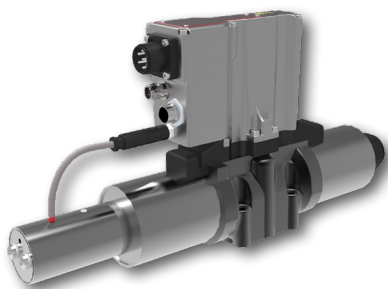

PRM9-10

 Size 10 (D05) • Q_{max} 60 l/min (16 GPM) • p_{max} 350 bar (5100 PSI)

Technical Features

- › Direct acting proportional control valve with integrated digital onboard electronics (OBE), proportional control, spool and process feedback
- › Control valve with subplate mounting surface acc. to ISO 4401, DIN 24340 (CETOP 05) standards
- › The valve opening and resulting flow rate can be modulated continuously in proportion to the reference signal
- › Digital electronics allows fine control of the valve spool position, reducing hysteresis and response time and optimizing the performance of the valve
- › Used for e.g. position and speed control of hydraulic actuators
- › Wide range of interchangeable spools available
- › The settings of electronics can individually be adjusted by a parametrization software
- › Easy to connect via USB ↔ Micro-USB ports
- › Optical feedback of valve status through three LEDs
- › The valve is zinc-coated with the enhanced surface corrosion protection 520 h in NSS acc. to ISO 9227
- › High hydraulic power limits and smooth running characteristic
- › Improved shock and vibration behavior
- › CANopen connectivity

Functional Description

The proportional directional control valve PRM9 consists of a cast iron housing, a special control spool, two centering springs with supporting washers, one or two proportional solenoids, a position sensor and a digital onboard electronic. The measurement system of the position sensor is based on a differential transformer with a sensor core and its electronic evaluation unit.

The unit, containing the digital onboard electronics, is mounted on the valve housing. Due to this, the solenoids are able to be connected directly to the electronics without any cabling at all. The connection of the position sensor to the control unit is provided by a cable.

For main contacting of the digital electronics, the MIL-C5015 (6 + PE) connector is available for connecting the supply, the setpoint signal and monitor signal of the internal piston position. Other connection possibilities are directly related to the selected valve variant. These are, in detail, M12 x 1, 5-pin, for the bus connection in the standard version CANopen and also M12 x 1, 5-pin, for connecting an external sensor (of an external process variable).

The digital control unit utilizes pulse-with-modulation (PWM) and supplies the solenoids with current, proportionally to the control signal. The supply current is additionally modulated with a dither frequency and an amplitude.

Further / individual functional parameters like ramp, offset, deadband, max. current, etc. can be adjusted with the PRM9 parametrization software. Therefore, a standard computer can be connected with the valve by USB (USB-A (PC) ↔ μ-USB (valve)).

The factory configuration is set individually for each valve. The configuration data file as well as the parametrization software and the fieldbus data file can be downloaded from the ARGO-HYTOS website.

The PRM9 is available with following model options:

Models with standard OBE

- E02S02** internal spool position feedback
- E04S02** internal spool position and external feedback

Models with OBE and CANopen connectivity

- E02S02-CA** internal spool position feedback, CANopen connectivity
- E04S02-CA** internal spool position and external feedback and CANopen connectivity

All models are equipped with an optical feedback (standard: 2 LEDs; with CANopen: 3 LEDs). The flash code of the LED indicates the current status of the valve (for further details see the operating manual of the valve). As a standard, the proportional valve is delivered with factory setting. For a model including an external feedback (E04), contact the manufacturer for specific data.

Technical Data

ISO 4401-05-04-0-05

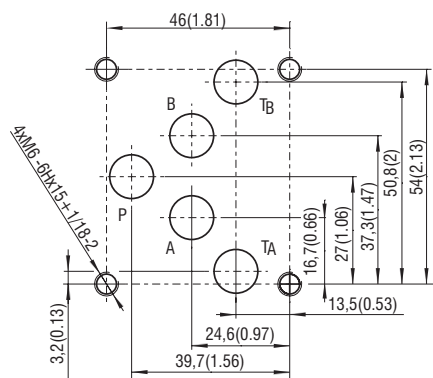

Ports P, A, B, T - max. \varnothing 11.2 mm (0.44 in)

Valve size	10 (D05)	
Max. operating pressure at ports P, A, B	bar (PSI)	350 (5100)
Max. operating pressure at port T	bar (PSI)	210 (3046)
Fluid temperature range (NBR)	°C (°F)	-30 ... +80 (-22 ... +176)
Fluid temperature range (FPM)	°C (°F)	-20 ... +80 (-4 ... +176)
Ambient temperature max.	°C (°F)	-40 ... +50 (-40... +122)
Nominal flow rate Q_n at $\Delta p=10$ bar (145 PSI)	l/min (GPM)	30 (7.9) / 60 (15.9)
Hysteresis - closed position loop	%	< 0.5
Protection degree EN 60 529	IP65 & IP67	
Weight - valve with 1 solenoid - valve with 2 solenoids	kg (lbs)	5.1 (11.2) 6.6 (14.6)
Shock & vibration	Sinus 10 g, max ampl. 0.75 mm, 10-2000 Hz Shock 30 g, half sinus 11ms	
Electromagnetic compatibility (EMC)	DIN EN 61000-4-2 DIN EN 61000-4-3 DIN EN 61000-4-4 DIN EN 61000-4-5 DIN EN 61000-4-6 DIN EN 61000-4-8	
	Data Sheet	Type
General information	GI_0060	Products and operating conditions
Coil types / Connectors	C_8007 / K_8008	
Mounting interface	SMT_0019	Size 10
Spare parts	SP_8010	
Subplates	SP_0002	DP*-10

Ordering Code

PRM9-10 / - -

Proportional Directional Control Valve, with Digital Onboard Electronics and Internal Feedback

Valve size

Spool symbols

see the table „Spool Symbols“

Nominal flow rate at $\Delta p = 10$ bar (145 PSI)

flow 30 l/min (7.9 GPM)

flow 60 l/min (15.6 GPM)

30

60

Nominal solenoid supply voltage

24V DC

24

No designation
V

A
B

Standard installation side of position transducer acc. of Spool Symbols table, other version consult with factory for their feasibility and availability

Surface treatment
zinc-coated (ZnNi), ISO 9227 (520 h)

Seals
NBR
FPM (Viton)

Installation side of position transducer
spool position transducer at side of port „A“
spool position transducer at side of port „B“

E02S02

E04S02

E02S02-CA

E04S02-CA

OBE, spool position transducer
OBE, spool position transducer and external feedback
OBE CANopen, spool position transducer
OBE CANopen, spool position transducer and external feedback

- For proportional valves with two solenoids, one solenoid must be de-energized before the other solenoid can be charged.
- Mounting bolts M6 x 40 DIN 912-10.9 or studs must be ordered separately. Tightening torque is 14 Nm (10.3 lbf.ft).
- Besides the shown, commonly used valve versions other special models are available.
- Contact our technical support for their identification, feasibility and operating limits.

Spool Symbols

Type	Symbol	Type	Symbol
2Z51		3Z11	
2Z11			
2Y51		3Y11	
2Y11			

Technical Data of Proportional Directional Control Valve

Solenoid data		
Type of coil	V	24
Limiting current	A	2.5
Resistance at 20 °C (68 °F)	Ω	4.73

Electronics Data		
Supply voltage with polarity inversion protection	V	19.2...24...28
Input		
Command signal (according to customer setting)		±10 V; 0...10 V; 0...Uref; Uref/2 ± Uref; ±10 mA; 0...20 mA; 4...20 mA
External feedback signal (according to customer setting)		±10 V; 0...10 V; 0...Uref; Uref/2 ± Uref; ±10 mA; 0...20 mA; 4...20 mA
Output		
Spool position of monitoring signal	V	±10 V
Output current to solenoids	A	2x PWM output stages up to 4 A
Resolution of the A/D converter	bit	12
PWM frequency	kHz	18
Cycle time	μs	200
Parameter setting: By PRM9 parametrization software. Connection via USB-A to μ-USB cable		

Frequency Response closed position loop, for E02S02 model

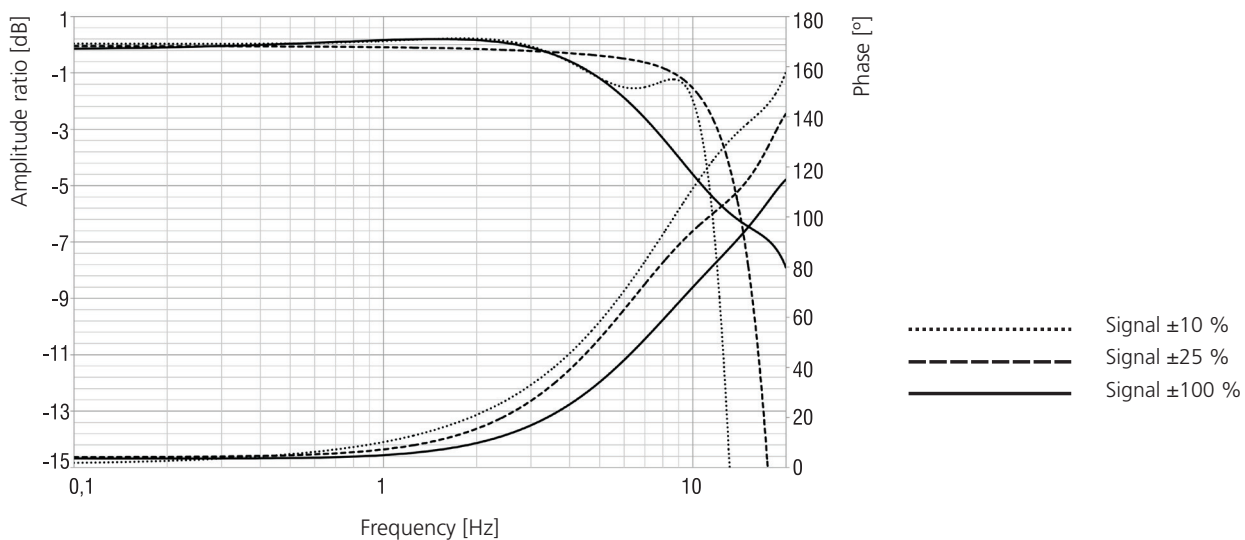

Characteristics measured at $v = 32 \text{ mm}^2/\text{s}$ (156 SUS)

Step response

- E02S02 model only (internal position feedback)

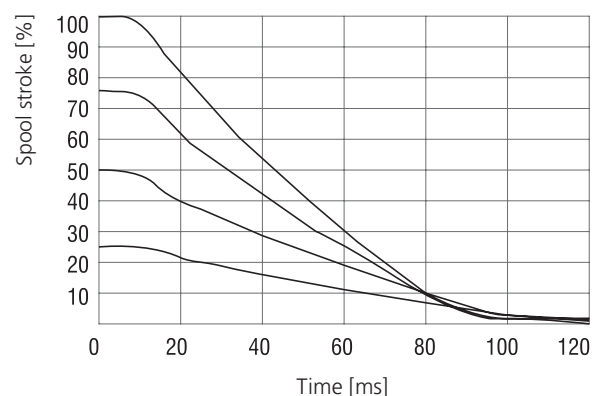
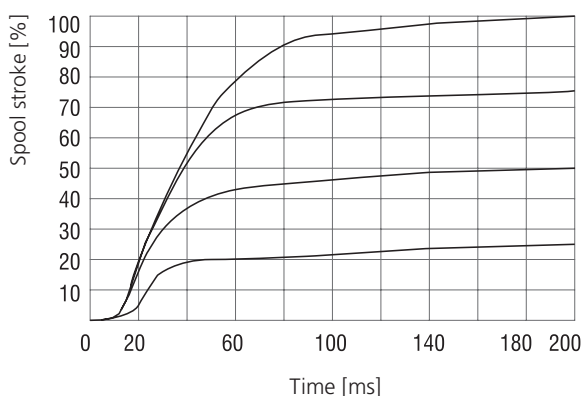

Characteristics measured at $v = 32 \text{ mm}^2/\text{s}$ (156 SUS)

Operating limits: Flow direction $P \rightarrow A / B \rightarrow T$ or $P \rightarrow B / A \rightarrow T$
 - E02S02 model only

Z11/30 Nominal flow 30 l/min (7.9 GPM)

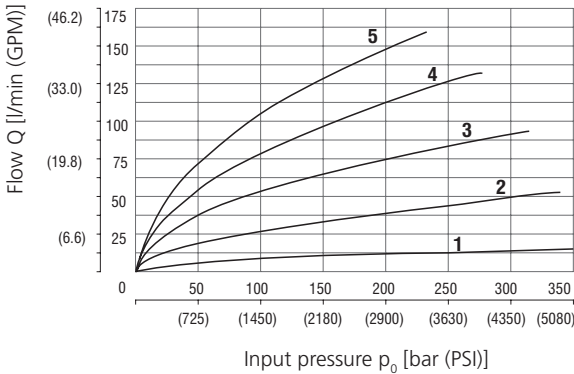

Z11/60 Nominal flow 60 l/min (15.9 GPM)

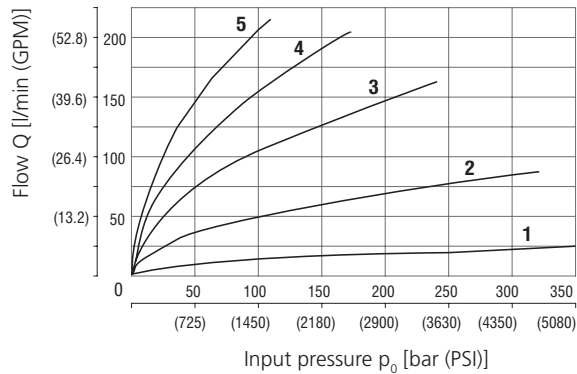

Y11/30 Nominal flow 30 l/min (7.9 GPM)

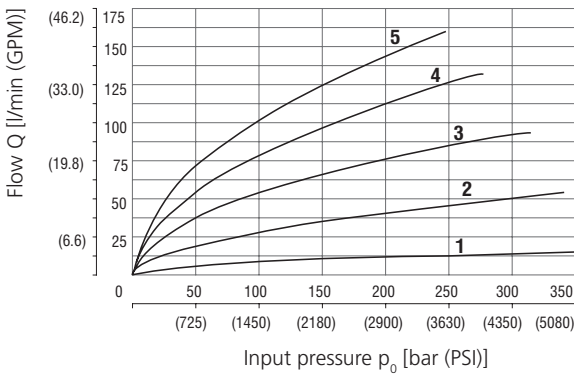

Y11/60 Nominal flow 60 l/min (15.9 GPM)

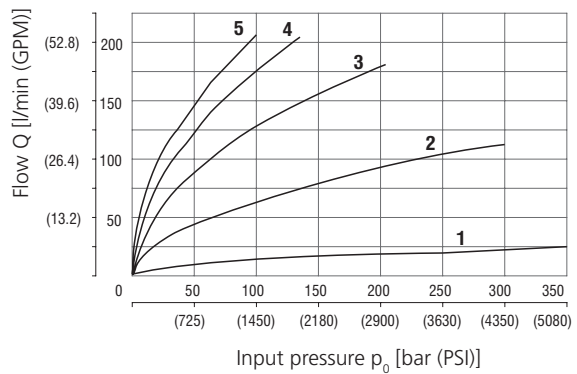

Command signal:
 1 = 20 %
 2 = 40 %
 3 = 60 %
 4 = 80 %
 5 = 100 %

Flow characteristics: Flow direction $P \rightarrow A / B \rightarrow T$ or $P \rightarrow B / A \rightarrow T$
 - E02S02 model only

Z11/30 Nominal flow 30 l/min (7.9 GPM) at $\Delta p = 10 \text{ bar}$ (145 PSI)

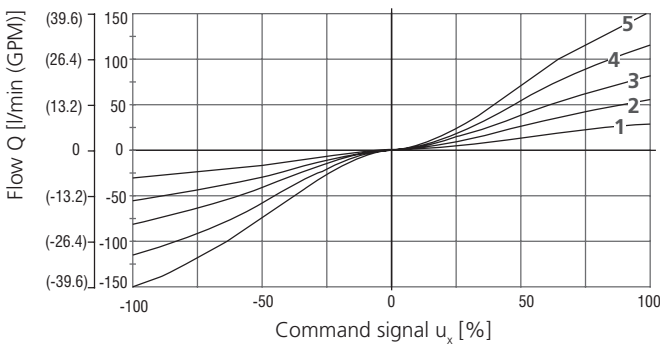

Z11/60 Nominal flow 60 l/min (15.9 GPM) at $\Delta p = 10 \text{ bar}$ (145 PSI)

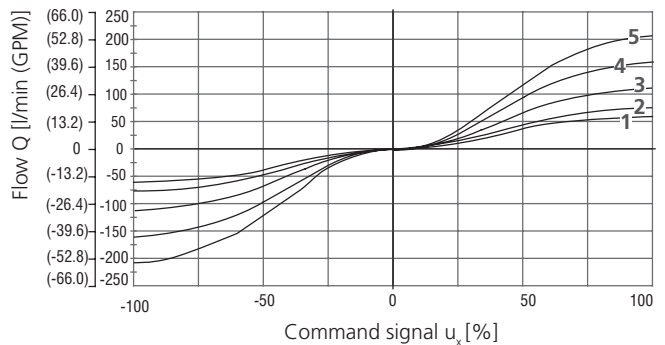

Y11/30 Nominal flow 30 l/min (7.9 GPM) at $\Delta p = 10 \text{ bar}$ (145 PSI)

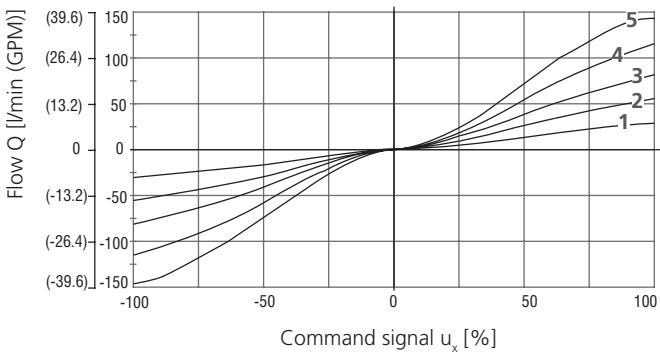

Y11/60 Nominal flow 60 l/min (15.9 GPM) at $\Delta p = 10 \text{ bar}$ (145 PSI)

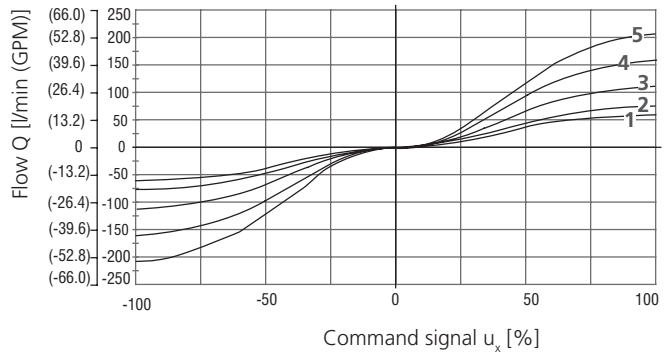

Δp = Valve pressure differential
 (inlet pressure p minus load pressure and return pressure p_r)

1	$\Delta p = 10 \text{ bar}$ (145 PSI)
2	$\Delta p = 50 \text{ bar}$ (725 PSI)
3	$\Delta p = 100 \text{ bar}$ (1450 PSI)
4	$\Delta p = 200 \text{ bar}$ (2900 PSI)
5	$\Delta p = 350 \text{ bar}$ (5076 PSI)

Factory Settings

Item	Model							
	E02S02		E04S02		E02S02-CA		E04S02-CA	
	1 Magnet	2 Magnets	1 Magnet	2 Magnets	1 Magnet	2 Magnets	1 Magnet	2 Magnets
Command signal	0...10 V	±10 V	0...10 V	±10 V	0...10 V	±10 V	0...10 V	±10 V
Signal external feedback	-	-	0...10 V		-	-	0...10 V	
Spool position of monitoring signal	0...10 V	±10 V	0...10 V	±10 V	0...10 V	±10 V	0...10 V	±10 V

Connectors

10

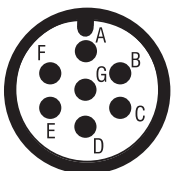

Main supply connector 6+PE MIL (EN 175201-804)

PIN	Technical data
A	Supply 24 V
B	GND (Supply)
C	GND (Monitor)
D	INPUT
E	GND (Input)
F	Monitor
G	PE

9



Connector M12x1, plug (5-pol, A-Code), CANopen (optional)

PIN	Technical data
1	n.c.
2	n.c.
3	CAN GND
4	CAN HIGH
5	CAN LOW

8



Connector M12x1, socket (5-pol, A-Code), external feedback (optional)

PIN	Technical data
1	Supply 24 V
2	Signal
3	GND
4	n.c.
5	n.c.

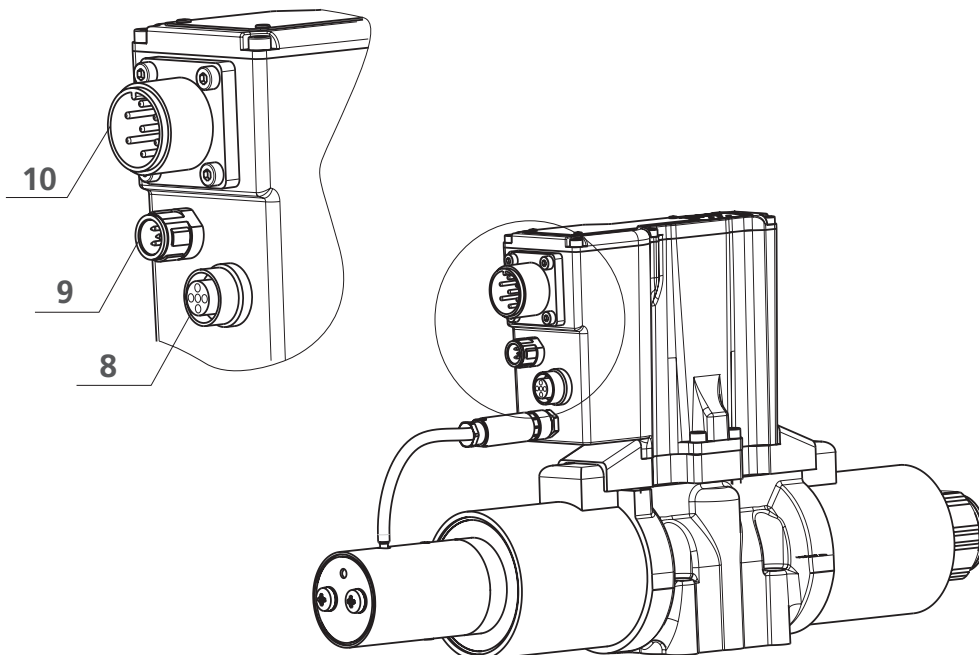

Dimensions in millimeters (inches)

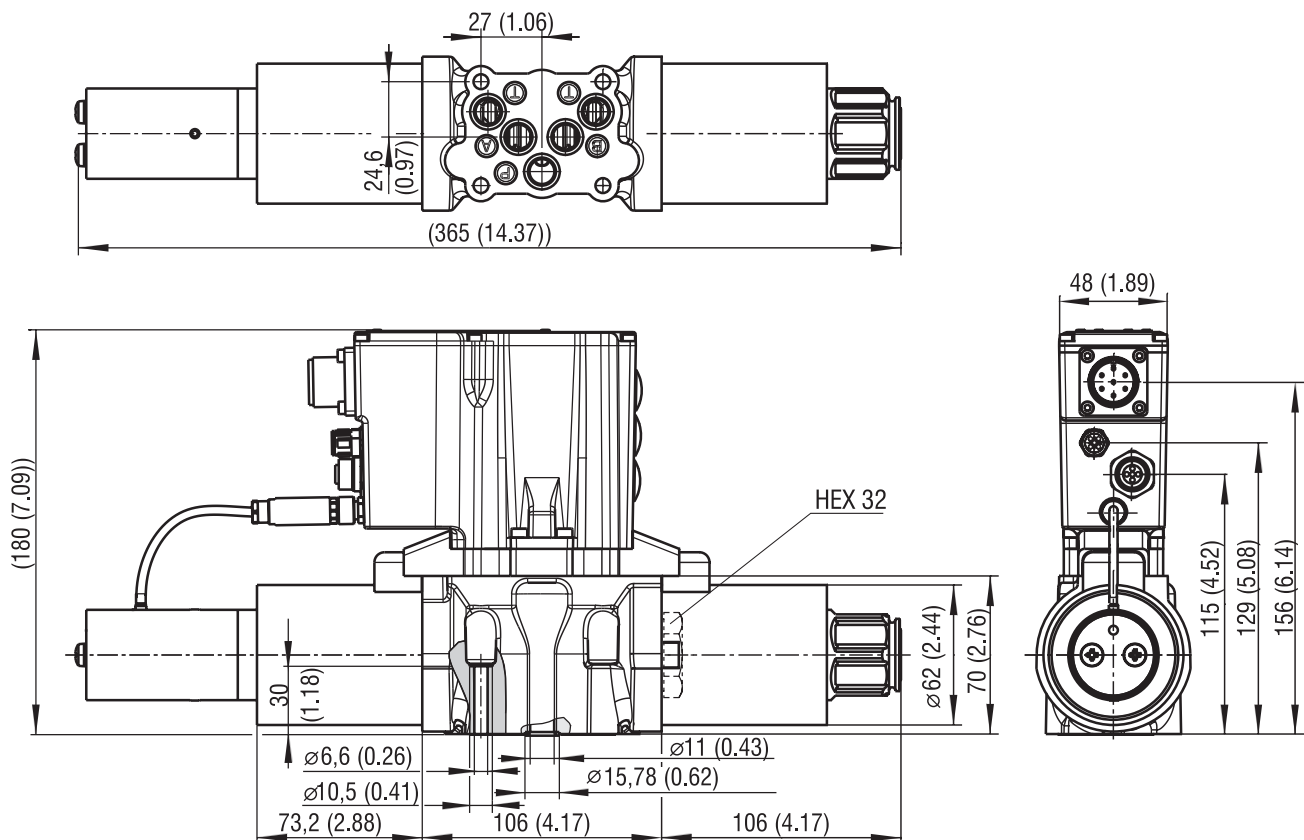

- 1 Solenoid a
- 2 Solenoid b
- 3 Manual override
- 4 Position sensor
- 5 4 mounting holes
- 6 Solenoid fixing nut
- 7 Square ring 12.42x1.68 (5. pcs.),supplied in delivery packe
- 8 Connector M12x1, socket (5-pol, A-Code), external feedback (optional)
- 9 Connector M12x1, plug (5-pol, A-Code), CANopen (optional)
- 10 Main supply connector 6+PE MIL (EN 175201-804)
- 11 Aluminium housing with integrated digital electronics
- 12 μ -USB connection
- 13 Encoder Baud Rate (optional)
- 14 Encoder Node-ID (optional)
- 15 Name plate
- 16 Status LEDs

