

Proportional directional valves with linear motor

PRL1

Size 06 (D03) • Q_{max} 63 l/min (17 GPM) • p_{max} 350 bar (5100 PSI)

Technical Features

- › Proportional directional control valve with high response speed to a change of command signal
- › Connecting diagram size 06 according to standards ISO 4401 and DIN 24340 (CETOP 03)
- › The valve is suitable for continuous control of flow rate or pressure (as a pilot valve)
- › proportionally to the input command signal
- › It is designed for control of hydraulic cylinders and rotational hydraulic motors
- › High reliability of design solution
- › It is required the same cleanliness degree of the working fluid as at standard valves
- › The direct spool control improves the dynamic of valve and reduces dependence on operating pressure
- › Valve control with external or integrated electronic control unit in the form of connector plug (ECU)
- › Additionally, the valve can be equipped with a manual override of valve spool
- › In the standard version, the valve housing is phosphated for basic surface corrosion protection and as preparation for painting. Steel parts are zinc-coated for 240 h salt spray protection acc. to ISO 9227

Technical Data

Valve size		06 (D03)			
Max. operating pressure	bar (PSI)	350 (5080)			150 (2180)
Rated flow Δp = 70 bar	l/min (GPM)	3.2 (0.85)	16 (4.23)	32 (8.45)	63 (16.6)
Rated flow Δp = 10 bar	l/min (GPM)	1.1 (0.29)	6.3 (1.66)	12.5 (3.30)	25 (6.60)
Max. current coil for 12 V	A	3			
Max. current coil for 24 V	A	2.5			
Hysteresis	%	< 7			
Threshold	%	< 2			
Fluid temperature range	°C (°F)	-30 ... +80 (-22 ... +176)			
Ambient temperature, max.	°C (°F)	-30 ... +50 (-22 ... +122)			
Weight	kg (lbs)	1.8 (3.97)			

Flow losses in l/min		Spool lap			
(at input pressure 100 bar, viscosity 32 mm ² /s and middle position of spool)					
		0	1	2	3
PRL1-06-03--24 (12)	l/min	< 0.8	< 0.2	< 0.2	< 2.0
PRL1-06-16--24 (12)		< 1.5	< 0.2	< 0.2	-
PRL1-06-32--24 (12)		< 1.5	< 0.2	< 0.2	-
PRL1-06-63--24 (12)		< 1.5	< 0.2	< 0.2	-

Technical data of electronic control unit EL7		
Operating supply voltage U _{cc}	V DC	9 ... 32
Reference voltage U _{ref}	V DC	5
Max. current at U _{ref}	mA	20
Types of input command signal, when EL7 is used		see datasheet EL7*
Max. output current / 1 coil	A	3
PWM frequency	Hz	80 ... 1000
Resolution of A/D converters	bit	12
Ramp function	s	0 ... 45
Dither – amplitude*	% from I _{max}	0 ... 30 % from I _{max}
Dither – frequency*	Hz	60 ... 300

* When the dither is activated, the PWM frequency is automatically set to 15 kHz

	Datasheet	Type
General information	GI_0060	Products and operating conditions
Mounting interface	SMT_0019	Size 06
Subplates	DP-04 (06, 10)	Size 06
Spare parts	SP_8010	

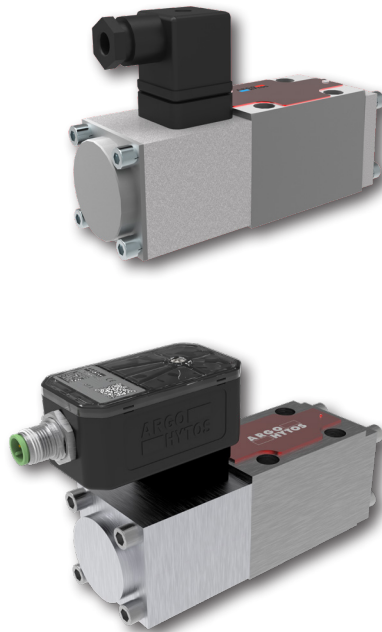

ISO 4401-03-02-0-05

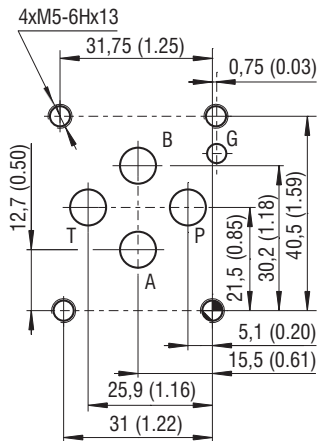

Ports P, A, B, T - max Ø7,5 mm (0.29 in)

Spool Symbols

Typ	PRL1-06-...-...	PRL1-06-...-...N
Z11		
Y11		
H11		

Functional Description

The PRL1 proportional directional control valve is designed for continuous remote control of rotational hydromotors and hydraulic cylinders in mobile and stationary applications. Direct spool operation by linear motor and robust design increase valve function reliability and reduce the required cleanliness of the working fluid. The hydraulic part consists of a cast-iron body with a fitted spool. The control part consists of a linear motor. The armature of the linear motor is centred by springs and the working gaps are premagnetized in opposite directions by permanent rare earth magnets. When the coil is energized, the armature with spool moves from the middle position. Spool position and volumetric flow are proportional to the control current. The moving direction of the spool and flow direction depend on current flow direction. In the event of supply voltage disconnection or cable failure the motor armature with the spool moves back to the basic middle position. The manual override allows smooth adjustment of the spool by screwing the hexagonal socket screw 4 in the flange.

The valve can be controlled by an external electronic control unit (EL7-E) or integrated electronic control unit (EL7-I) in the form of connector plug. Although the PRL1 proportional directional control valve is primarily designed for control of both flow direction and volume (size), it can be used for pressure control as a pilot valve for proportional directional control valves of larger sizes. Due to their dynamic properties the PRL1 proportional directional control valves are used for control of closed loop control systems.

Electronic control unit EL7

The ECU EL7 allows direct independent control of the valve with an analogue input command signal or connection of the valve to the CANBus control system of a machine.

Valve with a bipolar linear motor controlled by external electronic control unit EL7-E

The valve can be controlled by external ECU EL7-E designed for connection to a DIN rail. The user electrically connects the ECU to the valve with a cable.

Selection and setting of ECU parameters is described in **datasheet HA 9152**.

Valve with a bipolar linear motor controlled by integrated electronic control unit EL7-I

The ECU in the form of connector plug is simply mounted on the socket of connector EN 175301-803-A of solenoid coil and fastened with a fixing screw.

Selection and setting of ECU parameters is described in **datasheet HA 9151**.

Ordering Code

PRL1-06-□-□-□-□

Proportional directional valves with linear motor

Nominal size

ISO 4401-03-02-0-05,
DIN 24340 (CETOP 03), size 06

Nominal flow in l/min at the pressure difference at the valve

Δp 70	(1015)	Δp 10	(145)	[bar (PSI)]	
3.2	(0.8)	1.1	(0.29)	[l/min (GPM)]	03
16	(4.2)	6.3	(1.7)	[l/min (GPM)]	16
32	(8.5)	12.5	(3.3)	[l/min (GPM)]	32
63	(16.6)	25.0	(6.6)	[l/min (GPM)]	63

Spool lap

„Z” zero	0
„Z” 25 % overlap	1
„Y” 25 % overlap	2
„H” pressure valve	3

No designation
N

Model
basic
manual override on the valve

No designation
EL7-A Electronic EL7-IA-3 with analogue input signal
EL7-C Electronic EL7-IC-3 for connection to the CAN bus

	Spool lap			
	0	1	2	3
PRL1-06-03-.-24 (12)	●	●	●	●
PRL1-06-16-.-24 (12)	●	●	●	
PRL1-06-32-.-24 (12)	○	○	○	
PRL1-06-63-.-24 (12)	○	○	○	

- common types
- restricted max. parameters.
consultation with the manufacturer necessary
Additional flow rates delivered by request.

Frequency Response

PRL1-06-16-0-24

$p_0 = 100$ bar
 $x = 25$ %

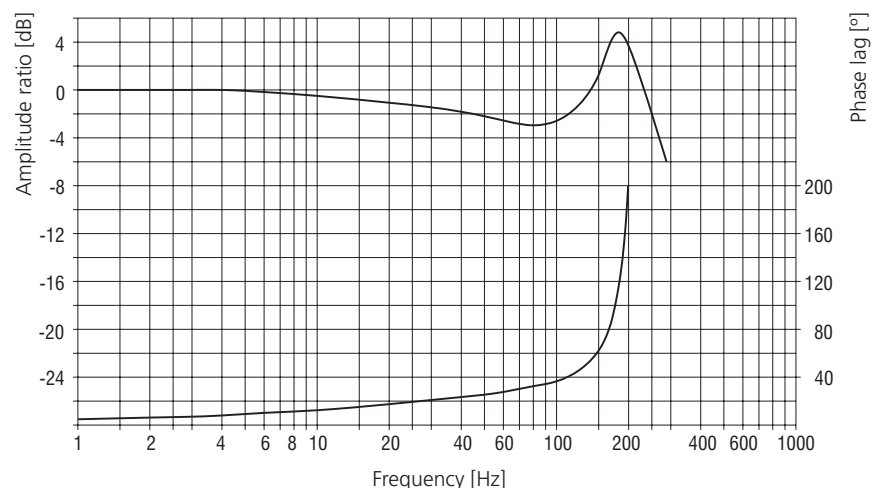

Performance Curves measured at $v = 32 \text{ mm}^2/\text{s}$ (156 SUS) and $t = 40 \text{ }^\circ\text{C}$ (104 $^\circ\text{F}$)

Flow characteristic

Pressure characteristic

Flow characteristic

Pressure characteristic

Spool lap 0

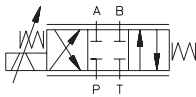

Q [l/min] / Command signal [%]

P_{A, P_B} [bar] / Command signal [%]

Spool lap 1

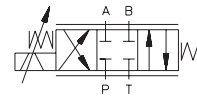

Q [l/min] / Command signal [%]

P_{A, P_B} [bar] / Command signal [%]

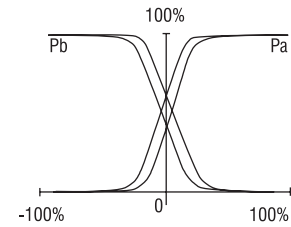
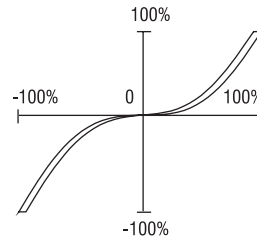
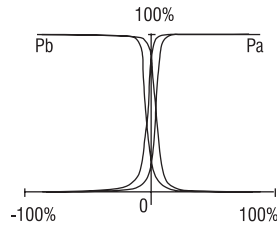
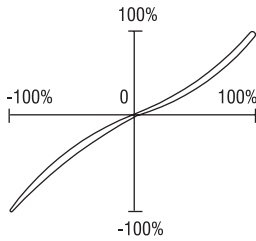

Spool lap 2

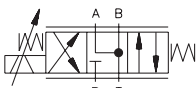

Q [l/min] / Command signal [%]

P_{A, P_B} [bar] / Command signal [%]

Spool lap 3

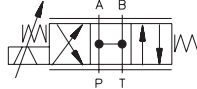

Q [l/min] / Command signal [%]

P_{A, P_B} [bar] / Command signal [%]

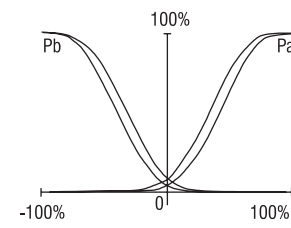
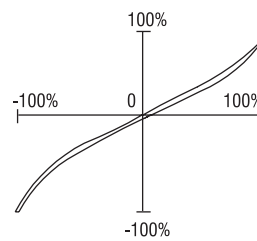
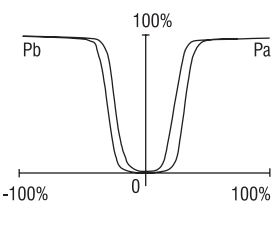
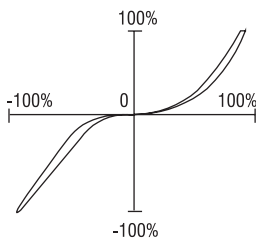

Characteristics measured at $v = 32 \text{ mm}^2/\text{s}$ (156 SUS) and $t = 40 \text{ }^\circ\text{C}$ (104 $^\circ\text{F}$)

Power characteristics:

flow direction $P \rightarrow A / B \rightarrow T$ or $P \rightarrow B / A \rightarrow T$

Flow characteristics:

flow direction $P \rightarrow A / B \rightarrow T$ or $P \rightarrow B / A \rightarrow T$

Nominal flow: 3.2; 16; 32; 63

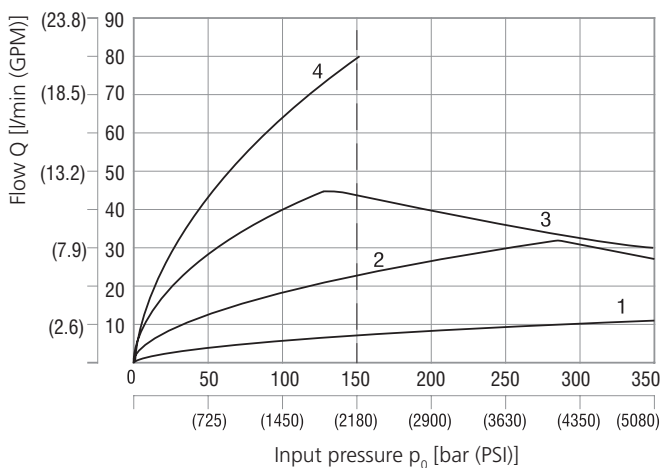

PRL1-06-16-0-24

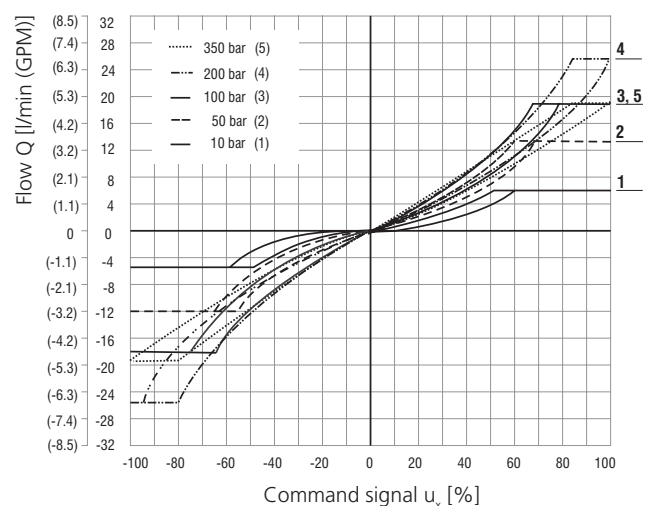

At max current flowing through the coil 24 V (12 V), 100 % command signal

1	PRL1-06-03-.-24 (12)	
2	PRL1-06-16-.-24 (12)	max. 350 bar (5080 PSI)
3	PRL1-06-32-.-24 (12)	
4	PRL1-06-63-.-24 (12)	max. 150 bar (2180 PSI)

Δp = Valve pressure differential

(inlet pressure p_0 minus load pressure and return pressure p_r)

1	$\Delta p = 10 \text{ bar}$ (145 PSI)
2	$p_0 = 50 \text{ bar}$ (725 PSI)
3	$p_0 = 100 \text{ bar}$ (1450 PSI)
4	$p_0 = 200 \text{ bar}$ (2900 PSI)
5	$p_0 = 350 \text{ bar}$ (5076 PSI)

Manual Override in millimeters (in)

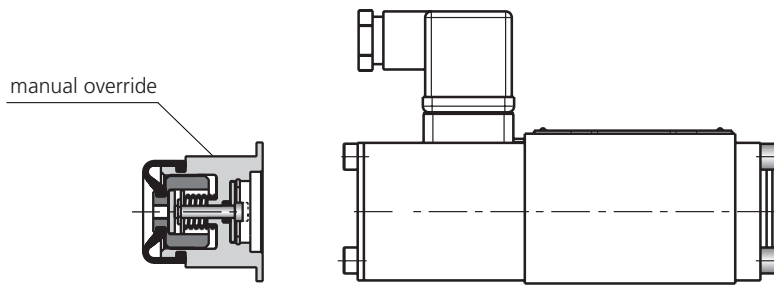

Dimensions in millimeters (in)

PRL1-06-...-..

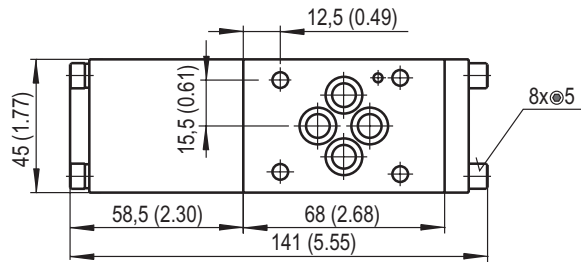

PRL1-06-...-..N

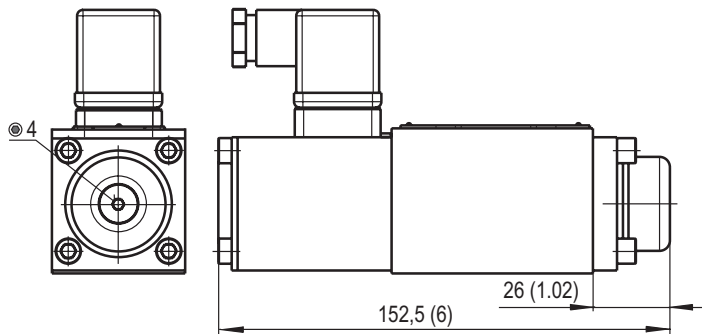
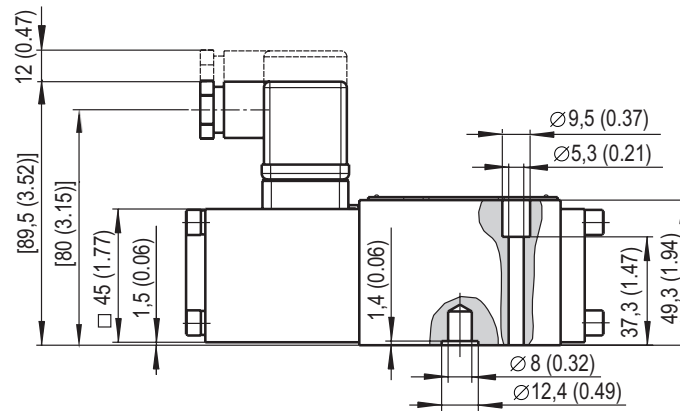

PRL1-06-...-EL7-lx-3..

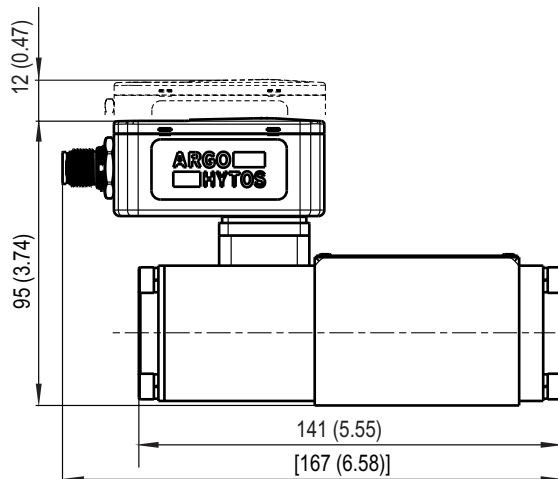

Mounting screws  8.9+1 Nm (6.6+0.7 lbf.ft)
M5 x 45 DIN 912-10.9