

Ventilating Filters - Vandalism Proof**L1.0808 · L1.0809**Connection up to M42 x 2 / 1⁵/₈-12 UN-2A · Nominal flow rate up to 850 l/min / 225 gpm

Ventilating Filter L1.0809



Ventilating Filter L1.0808

**Description****Application**

Ventilation of tanks for hydraulic and lubrication systems and gearboxes.

General

The oil levels in the tanks of hydraulic systems are subject to continuous variation due to temperature changes and the operation of cylinders and pressure vessels. In order to prevent over pressure in the tanks, an exchange of air with the external atmosphere is necessary. By the use of a ventilating filter, the outside air that is drawn in is filtered and the ingress of dust is therefore prevented.

Special features

The ventilation openings are designed that dust on the surface of the tank is not drawn in, and that the ingress of spray and rainwater is largely prevented.

The use in marine applications presents no problem due to the use of synthetic materials and stainless steel.

The patented vandalism proof ventilating filters can only be removed with the special tool supplied. This makes the removal of the ventilating filter or the ingress of dirt via the tank port considerably more difficult.

Design

Flow direction bi-directional (air IN/OUT).

The star-shaped pleating of the filter material results in:

- › large filter surfaces
- › low pressure drop
- › high dirt-holding capacities
- › long service life

Ordering options / versions*Integrated oil-level dipstick:*

A dipstick can be integrated in the ventilating filter for checking the oil level. Therefore, a separate dipstick or an additional opening in the tank is not required.

Double check valves:

By the use of double check valves, the exchange of air between the tank and the environment can considerably be reduced, whereby the ingress of dust is minimized and the lifetime of the ventilating filter can be increased.

With the double check valve, an over-pressure can be created in the tank in order to improve the suction conditions for the pumps. A further advantage is the reduction of spray water ingress and the loss of oil through the ventilating filter.

Vandalism proof version "Standard" (L1.0808):

Ventilating filters in the patented vandalism proof version can only be removed with the special spanner supplied (AF 47). This makes the removal of the ventilating filter or the ingress of dirt via the tank port considerably more difficult.

Vandalism proof version "Easy Lock" (L1.0809):

Ventilators in the patented "Easy Lock" version can only be removed with the special pin supplied.

Standard ventilating filters without vandalism proof see catalog sheet 50.10.

Filling and ventilating filters with and without vandalism proof see catalog sheet 50.30

Maintenance

Ventilating filters should be changed at least every 1000 operating hours, or at minimum once a year.

Characteristics

Nominal flow rate

Up to 850 l/min / 225 gpm (see Selection Chart, column 2).
The nominal flow rates indicated by ARGO-HYTOS are based on the following criteria:

- › Ventilating filters without double check valve:
 $\Delta p \leq 0.03 \text{ bar} / \Delta p \leq 0.44 \text{ psi}$ for air IN
- › Ventilating filters with double check valve:
 $\Delta p \leq 0.1 \text{ bar} / \Delta p \leq 1.45 \text{ psi}$ for air IN

Connection

Threaded ports according to

- › ISO 228 or DIN 13.

Sizes see Selection Chart, column 6
(other port threads on request).

Filter fineness

2 μm

Tested in a single pass test with ISO MTD.

Hydraulic fluids

Mineral oil and biodegradable fluids
(HEES and HETG, see info sheet 00.20).

Temperature range hydraulic fluid

-30 °C ... +100 °C (temporary -40 °C ... +120 °C)
-22 °F ... +212 °F (temporary -40 °F ... +248 °F)

Temperature range environment

-30 °C ... +100 °C
-22 °C ... +212 °C

Materials

| | |
|---------------|--------------------------|
| Cap: | Polyamide, GF reinforced |
| Base: | Polyamide, GF reinforced |
| Dipstick: | Stainless steel (1.4301) |
| Spanner: | Steel, galvanized |
| Gaskets: | NBR (FPM on request) |
| Filter media: | Composite, multi-layer |

Mounting position

No limitation, position on the tank see section Layout.

Δp-curves for complete filters in Selection Chart, column 3

D1 Pressure drop as a function of the **flow volume**
Air IN/OUT

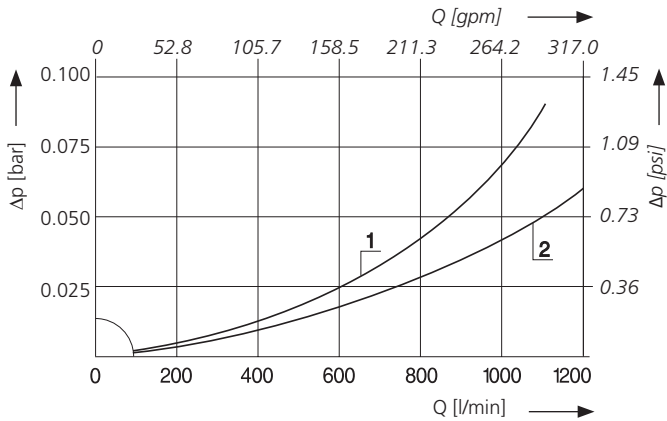

D2 Pressure drop as a function of the **flow volume**
Air IN

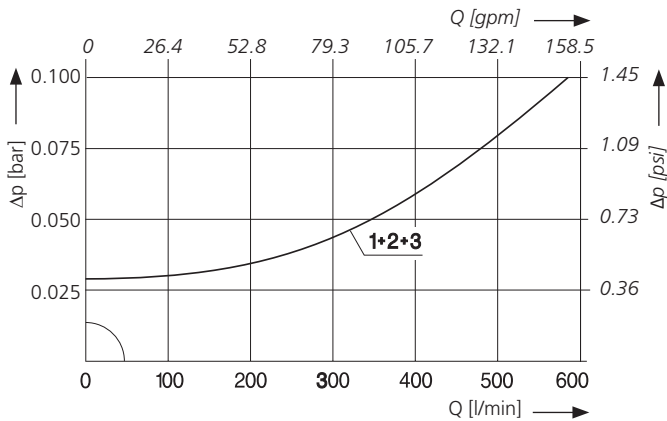

Pressure drop as a function of the **flow volume**
Air OUT

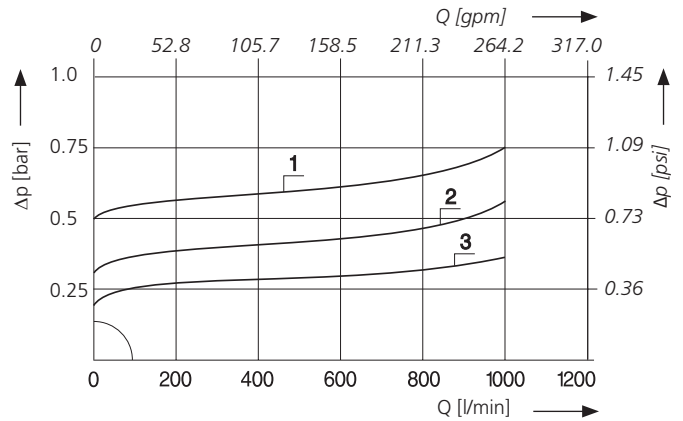

Filter fineness curves in Selection Chart, column 4

Dx Filtration ratio β as a function of particle size x tested in a single pass test with ISO MTD

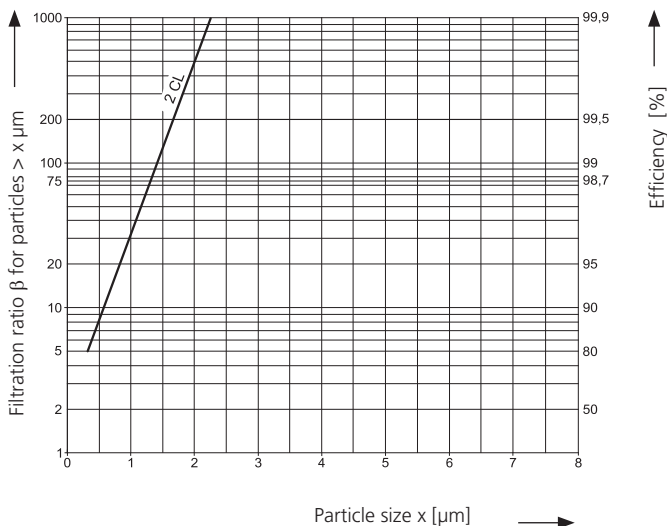

The abbreviation represents the following β -values resp. finenesses:

2CL

- › 2 μ m Composite
99.5% efficiency for particles of size 2 μ m tested in a single pass test with ISO MTD

For special applications, finenesses differing from these curves are also available by using special composed filter media.

Selection Chart

| Part No. | Nominal flow rate | Pressure drop see diagram D /curve no. | Filter fineness see diagr. Dx | Filter surface | Connection A | DCV ² -cracking pressure air IN | DCV ² -cracking pressure air OUT | Dipstick measurement pressure | Dipstick measurement L1 | Dipstick measurement L2 | Symbol | Weight | Remarks |
|------------|-------------------|---|--------------------------------------|-----------------|-----------------|--|---|-------------------------------|-------------------------|-------------------------|--------|--------|--------------------|
| 1 | l/min | 3 | 4 | cm ² | 6 | bar | bar | mm | mm | mm | 12 | g | 14 |
| L1.0808-00 | 850 | D1/2 | 2CL | 203 | M42 x 2.0 | - | - | - | - | - | 1 | 140 | with spanner AF 47 |
| L1.0808-53 | 550 ¹ | D2/3 | 2CL | 203 | M42 x 2.0 | -0.03 | 0.20 | - | - | - | 2 | 160 | with spanner AF 47 |
| L1.0808-52 | 550 ¹ | D2/2 | 2CL | 203 | M42 x 2.0 | -0.03 | 0.35 | - | - | - | 2 | 160 | with spanner AF 47 |
| L1.0808-61 | 550 ¹ | D2/1 | 2CL | 203 | M42 x 2.0 | -0.03 | 0.50 | - | - | - | 2 | 160 | with spanner AF 47 |
| L1.0809-00 | 650 | D1/1 | 2CL | 203 | G $\frac{3}{4}$ | - | - | - | - | - | 1 | 140 | with Easy Lock Pin |
| L1.0809-52 | 550 ¹ | D2/3 | 2CL | 203 | G $\frac{3}{4}$ | -0.03 | 0.20 | - | - | - | 2 | 160 | with Easy Lock Pin |
| L1.0809-51 | 550 ¹ | D2/2 | 2CL | 203 | G $\frac{3}{4}$ | -0.03 | 0.35 | - | - | - | 2 | 160 | with Easy Lock Pin |
| L1.0809-53 | 550 ¹ | D2/1 | 2CL | 203 | G $\frac{3}{4}$ | -0.03 | 0.50 | - | - | - | 2 | 160 | with Easy Lock Pin |
| L1.0809-01 | 850 | D1/2 | 2CL | 203 | M42 x 2.0 | - | - | - | - | - | 1 | 140 | with Easy Lock Pin |
| L1.0809-54 | 550 ¹ | D2/3 | 2CL | 203 | M42 x 2.0 | -0.03 | 0.20 | - | - | - | 2 | 160 | with Easy Lock Pin |
| L1.0809-55 | 550 ¹ | D2/2 | 2CL | 203 | M42 x 2.0 | -0.03 | 0.35 | - | - | - | 2 | 160 | with Easy Lock Pin |
| L1.0809-56 | 550 ¹ | D2/1 | 2CL | 203 | M42 x 2.0 | -0.03 | 0.50 | - | - | - | 2 | 160 | with Easy Lock Pin |

| 1 | gpm | 3 | 4 | inch ² | 6 | psi | psi | inch | inch | inch | 12 | lbs | 14 |
|------------|------------------|-------------|-----|-------------------|---------------------------|-------|------|------|------|------|----|------|--------------------|
| L1.0809-16 | 170 | D1/1 | 2CL | 31.5 | $\frac{3}{4}$ -14 NPT | - | - | - | - | - | 1 | 0.31 | with Easy Lock Pin |
| L1.0809-58 | 145 ¹ | D2/1 | 2CL | 31.5 | $\frac{3}{4}$ -14 NPT | -0.44 | 5.08 | - | - | - | 2 | 0.35 | with Easy Lock Pin |
| L1.0809-11 | 225 | D1/2 | 2CL | 31.5 | 1 $\frac{5}{8}$ -12 UN-2A | - | - | - | - | - | 1 | 0.31 | with Easy Lock Pin |
| L1.0809-57 | 145 ¹ | D2/1 | 2CL | 31.5 | 1 $\frac{5}{8}$ -12 UN-2A | -0.44 | 5.08 | - | - | - | 2 | 0.35 | with Easy Lock Pin |

¹ $\Delta p < 0.1$ bar / 1.45 psi for air IN

² Double check valve

Remarks:

The ventilating filters listed in this chart are standard filters. If modifications are required, e.g., with integrated dipstick or oil separator, we kindly ask for your request.

Dimensions

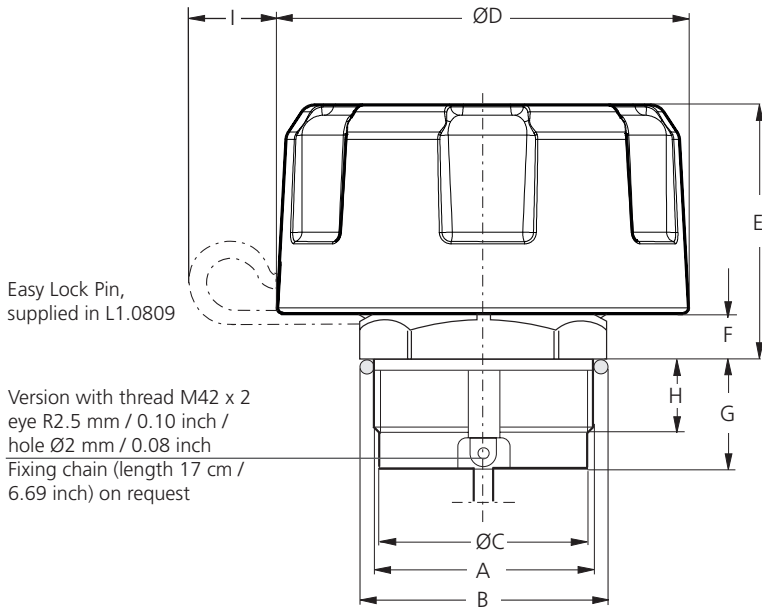

Recommended port sizes

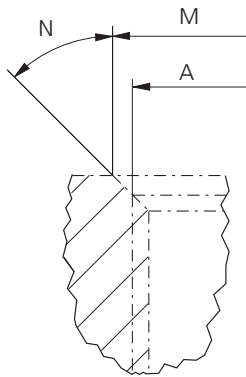

Spanner size (special wrench, supplied with L1.0808)

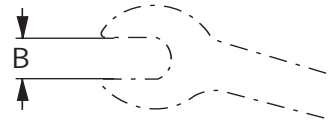

Measurements in mm

| Type | A ¹ | B | C | D | E | F | G | H | I | M | N |
|---------|------------------|-------|----|----|----|-----|------|------|----|------|-----|
| L1.0808 | M42 x 2 | AF 47 | 40 | 80 | 50 | 8 | 21 | 14 | - | 48 | 45° |
| L1.0809 | G ^{3/4} | AF 33 | 24 | 80 | 50 | 7.5 | 17.5 | 13.5 | 16 | as A | 45° |
| | M42 x 2 | AF 47 | 40 | 80 | 50 | 8 | 21 | 14 | 16 | 48 | 45° |

¹ The thread dimensions do not exactly conform to the DIN ISO standard thread (functioning with the DIN ISO standard thread is guaranteed).

Measurements in inch

| Type | A ¹ | B mm | C | D | E | F | G | H | I | M | N |
|---------|--|---------|------|------|------|------|------|------|------|------|-----|
| L1.0809 | ³ / ₄ -14 NPT ² | AF 33 | 0.94 | 3.15 | 1.97 | 0.30 | 0.69 | 0.53 | 0.63 | as A | 45° |
| | 1 ⁵ / ₈ -12 UN-2A | AF 47 | 1.57 | 3.15 | 1.97 | 0.31 | 0.83 | 0.55 | 0.63 | 1.89 | 45° |

¹ The thread dimensions do not exactly conform to the ANSI standard thread (functioning with the ANSI standard thread is guaranteed).

² For NPT threads we recommend the use of gasket strips.

Symbols

1

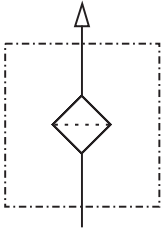

2

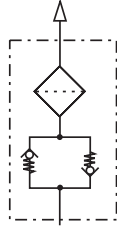

Layout

Sizes

The determining factor for selecting the size is the maximum over / under pressure allowed in the container.

For versions without double check valves, the initial pressure drop with a clean air filter should not exceed 0.03 bar / 0.44 psi.
For versions with double check valves, the initial pressure drop for air IN with a clean air filter should not exceed 0.1 bar / 1.45 psi.

Filter fineness

In the ideal case, the fineness of the ventilating filter matches the fineness of the system filter (see also CETOP RP 98 H).
By the use of filter fineness 2 CL the ingress of dust into the tank is effectively reduced.

Mounting

The ventilating filter should be mounted in a low-dust area of the machine and not in depressions in which water can collect.
For mobile use, the ventilating filter is to be mounted on the tank such that neither splashing oil from the inside nor spray water from the outside can reach the area of the ventilation opening.

Quality Assurance

Quality management according to DIN EN ISO 9001

To ensure constant quality in production and operation, ARGO-HYTOS filter elements undergo strict controls and tests according to the following ISO standards:

| | |
|-----------|---|
| ISO 2941 | Verification of collapse / burst pressure rating |
| ISO 2942 | Verification of fabrication integrity (Bubble Point Test) |
| ISO 2943 | Verification of material compatibility with fluids |
| ISO 3968 | Evaluation of pressure drop versus flow characteristics |
| ISO 16889 | Multi-Pass-Test (evaluation of filter fineness and dirt-holding capacity) |
| ISO 23181 | Determination of resistance to flow fatigue using high viscosity fluid |

Various quality controls during the production process guarantee the leakfree function and solidity of our filters.

Double check valves

By the use of double check valves, the exchange of air between the tank and the environment can considerably be reduced, whereby the ingress of dust is minimized and the lifetime of the ventilating filter is increased.

With the double check valve, a predefined level of pressure can be created in the tank in order to improve the suction conditions for the pumps.

The valve opening pressure required for the ventilating filter can be approximately determined with the ideal gas equation depending on the following system characteristics:

- › differential volume
- › volume of oil in the system
- › volume of air in the tank
- › operating temperatures

Calculation tool available.

Illustrations may sometimes differ from the original. ARGO-HYTOS is not responsible for any unintentional mistake in this specification sheet.