

General Information

Gear Pumps

Long-standing tradition

Experience, innovation, continuous optimization by means of mathematical analysis and testing – these are important prerequisites for the development and production of advanced products with wide application potential in both stationary and mobile applications. Our product portfolio includes valves for hydraulic circuit control, manifolds and HICs, as well as complete hydraulic drives. We manufacture standard catalog products as well as tailor-made products for specific applications.

We participate in the development and production of technical projects of our customers and we achieve excellence in our quality approach regarding people, products, processes and services.



Quality of products

The satisfaction of our clients is our top priority. When our customer’s machines operate properly and function flawlessly, we know that our efforts have been successful. Our certified quality assurance system is fully implemented in production and assembly processes. Our parts are produced using high-quality materials, purchased with an attestation from renowned suppliers. Machining is done with high accuracy and precision, using CNC machining centers. Key components of valves are heat-treated in order to withstand high wear and to meet the high requirements on service life. All of our products are tested on computer-controlled test benches in order to guarantee that they function properly and comply with the specifications; (thus, the risk of human error in testing is eliminated). The environmental resistance of surface finishes against corrosion is verified by an accredited laboratory. Selected products are certified by internationally recognized certification companies such as TÜV or CSA.

Gear pumps

External gear pumps are used to convert mechanical power into hydraulic energy. They are the source of flow and pressure in hydraulic circuits. They are characterized by a simple construction, reliability and lower purchase costs in comparison with other types of pumps. They are suitable for high loads over long periods of time. They are produced in a wide range of models and performances. Gear wheels and the input shaft are thermally processed in order to achieve high durability. The pumps are used in mobile technology, such as agricultural machines, construction machines and material handling equipment, as well as in the construction of various stationary hydraulic devices.

Overview of gear pumps

<p>GP1</p> <p>The GP1 series pumps have displacements V_g ranging from 1.0 to 9.8 cm³/ revolution. They are characterized by high operational reliability and durability. A wide range of construction designs is available with different connection dimensions and port locations. Flange, cover, and body are made of a high-quality aluminum alloy. Hydraulic compensation of axial clearance in our new generation of gear pumps improves the efficiency and reduces the noise level of the pumps. Our pumps can also be arranged as multiple pump units.</p>	
<p>GP2</p> <p>The GP2 series pumps have displacements V_g ranging from 4.5 to 32 cm³/ revolution. Flange and cover are made of cast iron, the body is made of high-strength aluminum alloy. Pumps use a 12-tooth gear to ensure a low level of noise.</p>	
<p>GP3</p> <p>The GP3 series pumps have displacements V_g ranging from 22.5 to 60 cm³/revolution. Flange and cover are made of gray cast iron, the body is made of high-strength aluminum alloy.</p>	
<p>GP0L, GP1L, GP2L, GP3L</p> <p>GP0L, GP1L, GP2L, GP3L pumps are "Lightline" products. These pumps are generally intended for circuits with a lower operating pressure. The pumps are not designed to be combined in multiple pump units.</p>	

Overview of parameters of the basic series

(This table provides an overview of comparative performance. Precise values are stated in the catalogue of individual pumps).

Gear Pumps - High Performance Version

Series	Geometrical volume V_g [cm ³ /rotation]	Nominal Flow Q [l·min ⁻¹] at 1500 RPM	Minimum rotations [min ⁻¹]	Maximum rotations [min ⁻¹]	Operating pressure p_2 [bar]	*Nominal input P_n [kW]
GP1	1.0 – 9.8	1.4 - 13.52	750	3500	250	0.73 - 4.01
GP2	4.5 – 32	6.14 - 46.08	650	3500	250	3.2 - 12.05
GP3	22.5 – 60	31.7 - 85.5	650	3000	250	16.51 - 29.1

Gear Pumps - Lightline Version

Series	Geometrical volume V_g [cm ³ /rotation]	Nominal Flow Q [l·min ⁻¹] at 1500 RPM	Minimum rotations [min ⁻¹]	Maximum rotations [min ⁻¹]	Operating pressure p_2 [bar]	*Nominal input P_n [kW]
GP0L	0.25 - 0.80	0.35 - 1.1	1000	7000	200	0.15 - 0.48
GP1L	0.8 - 8.0	1.1 - 11.04	1000	3500	230	0.55 - 5.54
GP2L	3.0 - 30	4.14 - 41.4	800	3500	230	2.08 - 12.65
GP3L	20 - 71	27.6 - 97.98	700	3000	230	13.86 - 37.95

* Nominal input for nominal rotations and nominal output pressure

Basic technical parameters

1. Working liquids

The pumps are designed to be used with mineral hydraulic oils and environmentally-friendly vegetable oil-based fluids.

Kinematic viscosity	
Recommended for permanent operation	20 to 80 mm ² s ⁻¹
Maximum (starting)*	1200 mm ² s ⁻¹
Minimum**	10 mm ² s ⁻¹

* At viscosity > 1000 mm²s⁻¹ the permitted operating pressure is < 10 bar and rotations < 1500 min⁻¹

** The operating mode in the viscosity range of 10 to 20 mm²s⁻¹ needs to be consulted with the manufacturer.

Maximum degree of fluid contamination		
Operating pressure p_2	Contamination – class ISO 4406	Filtration coefficient β_α
< 200 bar	21/18/15	$\beta_{25}(c) \geq 75$
> 200 bar	20/17/14	$\beta_{10}(c) \geq 75$

2. Pressure load

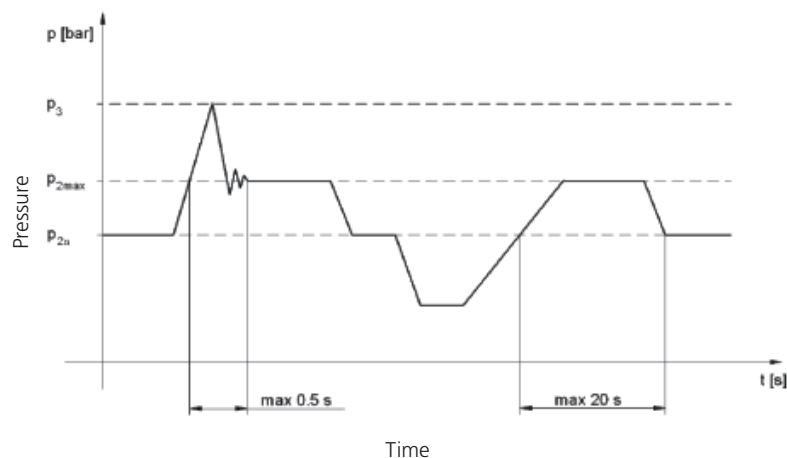

Maximum continuous pressure	p_{2n}	The maximum operating pressure of the pump for permanent operation without time limitation
Maximum intermittent pressure	p_{2max}	Maximum intermittent pressure, not exceeding 20 s
Peak pressure	p_3	Short-time pressure (fragments of a second) created during a sudden change of the operation mode. This pressure rate must not be exceeded.

3. Joining of pumps into groups

Multiple designs

Gear pumps are suitable for multiple setups, whereby the drive shaft for the 1st pump is extended to a second and even a 3rd pump. A coupling is fitted between each pair of pumps. In most cases each pump is isolated from its neighbor, i.e. the suction ports are separate from one another. A common suction port is also possible as an option.

Caution: Basically, the specifications for the single pumps apply, but with certain restrictions:

Max. / Min. speed – the limit of any pump must not be exceeded.

Torque – the shaft load of the first pump corresponds to the sum of the torques of all the pumps.

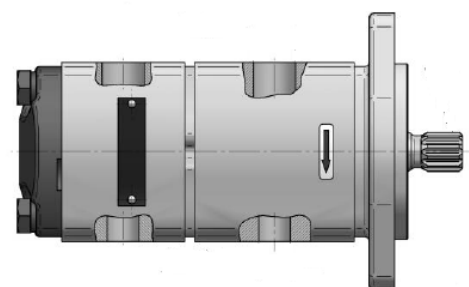
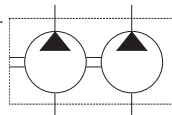

Basic technical parameters

4. Calculation formulas

Flow	
$Q = \frac{V_g \cdot n}{1000} \cdot \eta_v [dm^3 \min^{-1}]$	V_g – geometric volume of the pump [cm ³] n – rotations [min ⁻¹] η_v – volumetric efficiency [-]
Geometric volume	
$V_g = \frac{Q \cdot 1000}{n \cdot \eta_v} [cm^3]$	V_g – geometric volume of the pump [cm ³] n – rotations [min ⁻¹] η_v – volumetric efficiency [-]
Torque	
$M_k = \frac{V_g \cdot p}{20 \cdot \pi \cdot \eta_m} [Nm]$	p – required pressure at the output [bar] η_m – mechanical efficiency [-]
Input	
$P = \frac{V_g \cdot n \cdot p}{600 \cdot 1000 \cdot \eta_t} [kW]$	η_t – total efficiency [-]
Volume efficiency η_v	Represents volume losses. It depends on rotations and the output pressure and its value η_v ranges from 0,92 to 0,98.
$\eta_v = \frac{Q_{eff}}{Q_{th}}$	Q_{eff} – effective flow [l·min ⁻¹] Q_{th} – theoretical flow [l·min ⁻¹]
Mechanical efficiency η_m	Represents mechanical losses. Its values η_m is around 0,85
$\eta_m = \frac{M_{th}}{M_{eff}}$	M_{eff} – effective torque [Nm] M_{th} – theoretical torque [Nm]
Total efficiency η_t	It is calculated as the product of the mechanical and volume efficiency and it represents the difference between theoretical and actual required input.
$\eta_t = \eta_v \cdot \eta_m = \frac{P_{th}}{P_{eff}}$	P_{eff} – effective performance [kW] P_{th} – theoretical performance [kW]

5. Coupling

The construction design of the drive shafts ends corresponds to the transferred torque. The pump shaft must not be loaded by an additional external force in either the axial or radial direction. This is why it is recommended to use a flexible coupling. The maximum deviation of mutual alignment of the motor shaft and the centering pump diameter is 0.04 mm when using a coupling without a flexible element, and 0.1 mm when using a coupling with a flexible element, which partially balances alignment deviations. The perpendicularity of the seating front flange to the motor shaft is expressed as axial run-out and must not exceed 0.1 mm / 100 mm. The minimum distance of shaft ends is 0.5 mm. The selected coupling type must be able to transfer the maximum torque with sufficient safety.

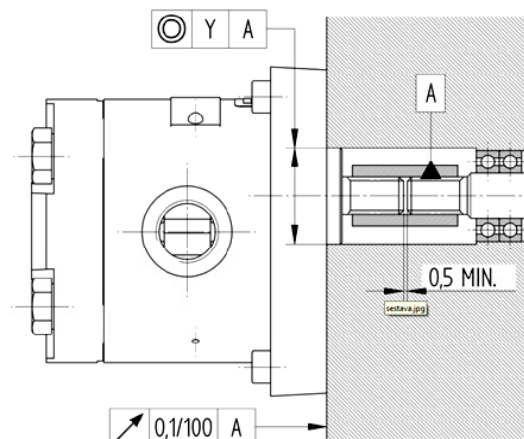

Basic technical parameters

6. Mounting, dismounting and operating instructions

The gear pump can be mounted in any position.

Make sure that the gear pump is clean and free of visible damage prior to mounting it. Protective covers prevent ingress of dirt into the inlet and outlet ports. These covers must not be removed until the pump is connected to the hydraulic circuit.

In order to make sure that proper mounting is possible, ascertain that all flange faces are clean and free of damage. The pump and the bellhousing are positioned with the help of the pilot diameter and fastened to each other with screws. The drive shaft of the pump is to be connected to the drive unit by means of a corresponding coupling. If this shaft is toothed, we recommend using a suitable lubricant for mounting.

Prior to initial operation, the sealing surfaces of the inlet and outlet ports must be checked for damages and dirt. It is vital that the threads be undamaged. Once the pump has been connected, it must be operated at minimum speed and without counter-pressure for at least 2 minutes. During this time, make sure that the pump runs freely, without excessive heating and unusual noise. If the operating fluid temperature is significantly higher than the temperature of the pump, the pump must not be subjected to loads before its temperature is equal to the temperature of the hydraulic fluid.

Protect the pump interior from dirt ingress by immediately closing the inlet and outlet ports as soon as the pump is disconnected from the hydraulic circuit. It is imperative to bleed the hydraulic circuit completely after the pump has been connected to it and whenever repair and/or maintenance work, as well as mounting operations have taken place anywhere in the circuit.

The quality of the hydraulic fluid must meet the required standards throughout the entire service life in order to maintain a permanent and sufficient level of lubrication of the pump. Furthermore, it is essential to not let the amount of fluid fall below the prescribed limit. If the fluid level is too low there may be turbulence, aeration, as well as an increase in fluid temperature, which then may lead to damaging of the pump.

A pressure relief function, which limits system pressure to the max. permissible pump pressure, must be integrated into the hydraulic system.

This valve must be installed in such a way as to protect it from improper handling. If multiple pumps are used, a suitable pressure relief valve must be installed in the circuit of each self-contained system.

Hydraulic Lines:

At a viscosity of 100 mm²/s and a flow rate of 1 to 1.5 m/s, the nominal inside diameter of the suction line must be dimensioned in such a way that the pressure in the suction port of the pump does not fall below -0.3 bar and does not exceed + 0.5 bar. In dimensioning the suction line, make sure that the flow rate will not exceed 8 m/s.

Operation:

Gear pumps are low-maintenance components, as long as the maintenance intervals are adhered to, and tests of the hydraulic medium, the connections and fastening points are performed according to schedule. Regular fluid changes are necessary to ensure that the entire hydraulic circuit functions properly. The intervals for changing the hydraulic medium are determined through inspections performed by the operator.

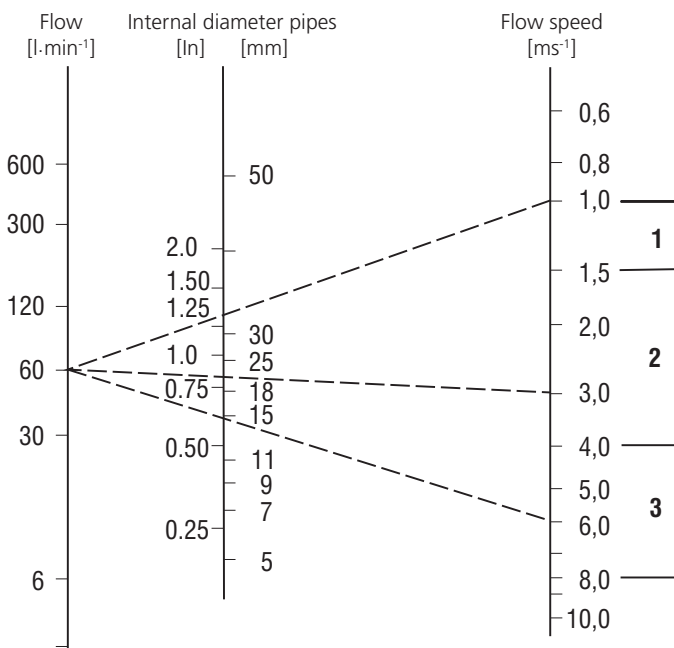

Graph for determining approximate diameter of the pipes for the given flow and liquid flow speed (area 1 for suction pipes, area 2 for return pipes, area 3 for pressure pipes).

When assembling the pump using two screws going through the pump, the following tightening torque of screws is required:

Connection screws	Tightening torque
2 screws with M8 thread	20 ± 3 Nm
2 screws with M10 thread	45 ± 2 Nm

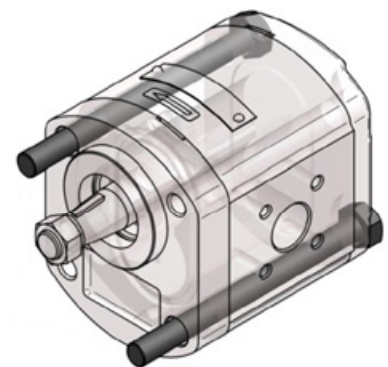

7. Storage

The storage time should not exceed one calendar year. Storage conditions: Temperature: from -20 °C to +40 °C, Humidity: from 40 % to 80 %

8. Warranty period and conditions

For "High performance" series: 3000 operation hours or two years from the sale date, whichever comes first.

For "Lightline" series: 1800 operation hours or one year from the sale date, whichever comes first.

The seller shall recognize a warranty claim and guarantee the product quality only if the operation conditions specified in the operation manual are adhered to.

In order to apply a warranty claim, the client must submit a failure report containing at least the following data:

type identification, serial number, number of operated hours.

The defective product must be sent to the seller complete, clean, with all connection ports plugged, and with the flange and drive shaft protected.

Adjustments or modifications of the pump are not allowed.

If the requirements specified above are not met, the warranty claim will be rejected and the product will be repaired only at the expense of the customer.

The seller does not accept any liability for damage caused by incorrect installation or use of the pump.