

Off-line Filters
FN 060 · FN 300

In-line mounting · Operating pressure up to 12 bar / 174 psi · Nominal flow rate up to 650 l/min / 172 gpm



Off-line Filter FN 060



Off-line Filter FN 300

Description
Application

Return-flow filter or off-line filter in hydraulic and lubrication systems.

Performance features
Protection against wear:

The EXAPOR®MAX 2 ultra-fine element meets the highest cleanliness standards, even at full flow.

Protection against failure:

The off-line filter includes a feature that guarantees a closed by-pass valve even at $v \leq 200 \text{ mm}^2/\text{s}$ / 930 SUS (cold start condition) within specified operating parameters.

Special design features
Housing cover:

The cover of the FN 060 can be opened without special auxiliary tools. Fold-out handle parts at the cover of the FN 300 facilitate the opening.

Automatic ventilation valve (only FN 300):

The quick automatic de-aeration after commissioning not only prevents components from consequential damage due to an excessive air content, but also avoids errors in the monitoring with optical particle counters.

Dirt retention valve:

At the bottom of the filter element, flow through from the inside to the outside, there is a dirt retention valve. This closes while pulling the filter element, which is hung up at the cover, out of the housing. Sedimented dirt is removed together with the filter element. Because of the cover design, the filter element change can be carried out almost without losing any oil.

Filter elements

Flow direction from the inside to the outside. The star-shaped pleating of the filter material results in:

- › large filter surfaces
- › low pressure drop
- › high dirt-holding capacities
- › particularly long maintenance intervals

Filter maintenance

By using a clogging indicator, the correct moment for maintenance is stated, what guarantees optimum utilization of the filter life.

Materials:

Filter head:	Aluminum alloy
Filter housing:	Steel (FN 060) Aluminum alloy (FN 300)
Cover:	Aluminum alloy
Seals:	NBR (FPM on request)
Filter media:	EXAPOR®MAX 2 - inorganic, multi-layer microfiber web

Accessories

Water-absorbing filter elements EXAPOR®AQUA are available on request.
For FN 060 there is a bleeder screw, and with Part No. FNS 060.1720 a fastening kit available on request.
Electrical and / or optical clogging indicators are available on request – with either one or two switching points resp. temperature suppression.
For dimensions and technical data of the clogging indicators see catalog sheet 60.30.

Characteristics**Operating pressure**

Max. 12 bar / 174 psi (FN 060)
Max. 10 bar / 145 psi (FN 300)

Nominal flow rate

Up to 650 l/min / 172 gpm (see Selection Chart, column 2)
The nominal flow rates indicated by ARGO-HYTOS are based on the following features:

- › closed by-pass valve at $v \leq 200 \text{ mm}^2/\text{s}$ / 930 SUS
- › element service life > 1000 operating hours at an average fluid contamination of 0.07 g per l/min / 0.27 g per gpm flow volume
- › flow velocity in the connection lines:
up to 10 bar $\leq 4.5 \text{ m/s}$ / 145 psi $\leq 14.8 \text{ ft/s}$

Filter fineness

3 $\mu\text{m(c)}$... 10 $\mu\text{m(c)}$
 β -values according to ISO 16889
(see Selection Chart, column 4 and Diagram Dx)

Dirt-holding capacity

The dirt-holding capacity values in grams from the ISO MTD test dust are in accordance with the ISO 16889 requirements (see Selection Chart, column 5).

Hydraulic fluids

Mineral oil and biodegradable fluids
(HEES and HETG, see info-sheet 00.20)

Temperature range

-30 °C ... +100 °C (temporary -40 °C ... +120 °C)
-22 °F ... +212 °F (temporary -40 °F ... +248 °F)

Viscosity at nominal flow rate

- › at operating temperature: $v < 35 \text{ mm}^2/\text{s}$ / 162 SUS
- › as starting viscosity: $v_{\text{max}} = 1200 \text{ mm}^2/\text{s}$ / 5560 SUS
- › at initial operation:
The recommended starting viscosity can be read from the diagram D (pressure drop as a function of the kinematic viscosity) as follows: Find the 70% Δp of the cracking pressure of the by-pass valve on the vertical axis. Draw a horizontal line so that it intersects the Δp curve at a point. Read this point on the horizontal axis for the viscosity.

Mounting position

Vertical, connection port at the bottom

Connection

Threaded ports according to ISO 228 or DIN 13 (FN 060) or flange mounting according to SAE-J518 (FN 300).
For sizes see Selection Chart, column 6 (other port threads on request).

Δp-curves for complete filters in Selection Chart, column 3

D1 Pressure drop as a function of the **flow volume** at $v = 35 \text{ mm}^2/\text{s} / 162 \text{ SUS}$ (0 = casing empty)

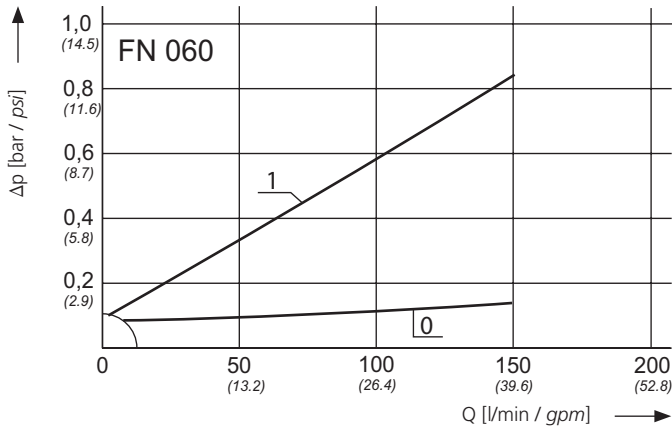

Pressure drop as a function of the **kinematic viscosity** at nominal flow

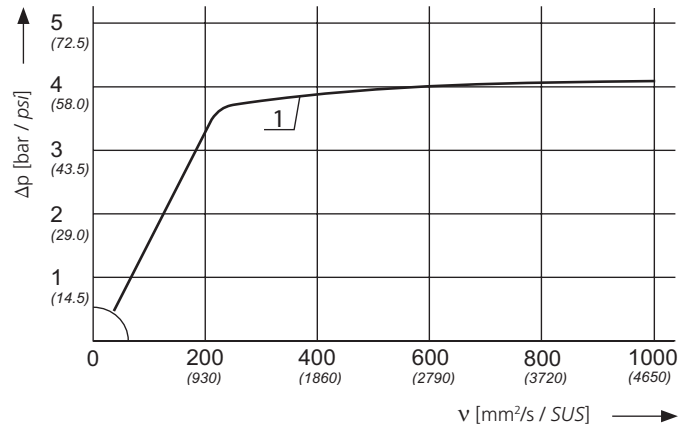

D2 Pressure drop as a function of the **flow volume** at $v = 35 \text{ mm}^2/\text{s} / 162 \text{ SUS}$ (0 = casing empty)

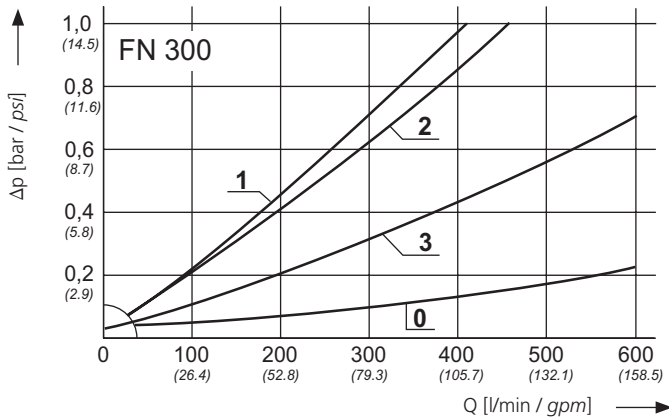

Pressure drop as a function of the **kinematic viscosity** at nominal flow

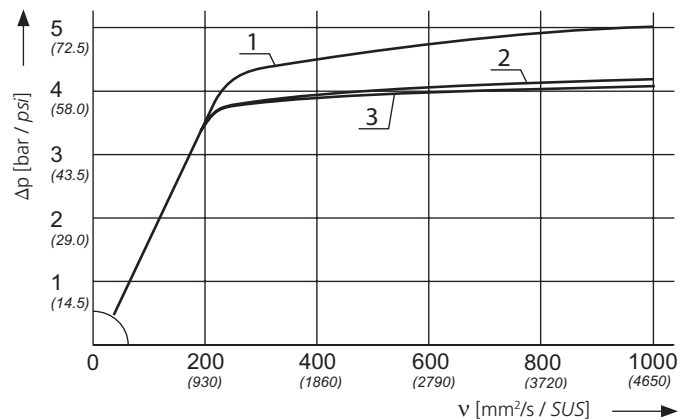

Filter fineness curves in Selection Chart, column 4

Dx Filtration ratio β as a function of particle size x obtained by the Multi-Pass Test according to ISO 16889

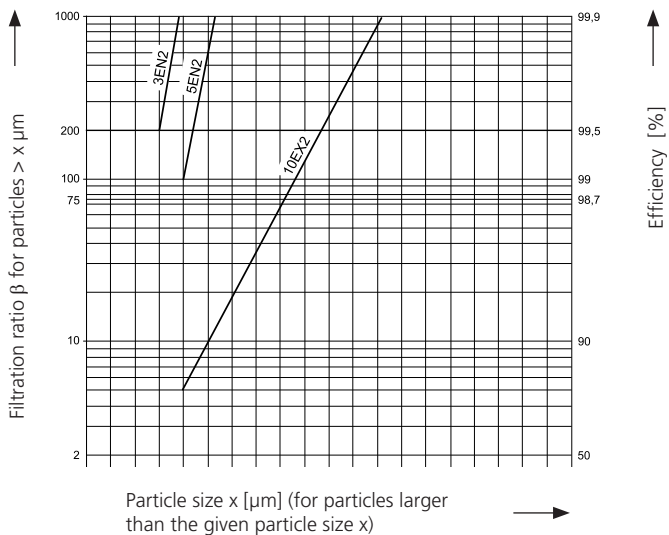

The abbreviations represent the following β -values resp. finenesses:

With EXAPOR®MAX2 and paper elements:

3EN2	=	$\bar{\beta}_3(c) = 200$	EXAPOR®MAX 2
5EN2	=	$\bar{\beta}_5(c) = 200$	EXAPOR®MAX 2
10EX2	=	$\bar{\beta}_{10}(c) = 200$	EXAPOR®MAX 2

For special applications, finenesses differing from these curves are also available by using special composed filter media.

Selection Chart

Part No.	Nominal flow rate		Pressure drop see diagram D /curve no.	Filter fineness s. diagram Dx	Dirt-holding capacity	Connection A/B		Cracking pressure of by-pass	Symbol	Replacement filter element Part No.	Weight		Clogging indicator	Remarks
	l/min	gpm				g	bar				psi	kg		
1	2	3	4	5	6	7	8	9	10	11	12			
FN 060-193	60	15.9	D1 /1	3EN2	290	G1	3.5	51	1	V7.1230-153	5	11.0	DG 041-32	–
FN 060-273	115	30.4	D1 /1	5EN2	220	G1	3.5	51	2	V7.1230-53	5	11.0	optional	–
FN 300-163	250	66.0	D2 /1	3EN2	740	SAE2½	3.5	51	2	V7.1560-103	20	44.1	optional	*
FN 300-153	300	79.3	D2 /2	5EN2	600	SAE2½	3.5	51	2	V7.1560-03	20	44.1	optional	*
FN 300-156	650	171.7	D2 /3	10EX2	400	SAE2½	3.5	51	2	V7.1560-06	20	44.1	optional	*

* with automatic ventilation valve

Optical or electrical indicators are available to monitor the clogging condition of the element.

For appropriate clogging indicators, please refer to catalog sheet 60.30.

Remarks:

- › The response / switching pressure of the clogging indicator must be lower than the cracking pressure of the by-pass valve (see Selection Chart, column 7).
- › Clogging indicators are optionally available and will be supplied separately if ordered.
- › The filter units listed in this chart are standard units. If modifications are required, e.g. with water-absorbing filter elements or with mounting set, we kindly ask for your request.

Dimensions

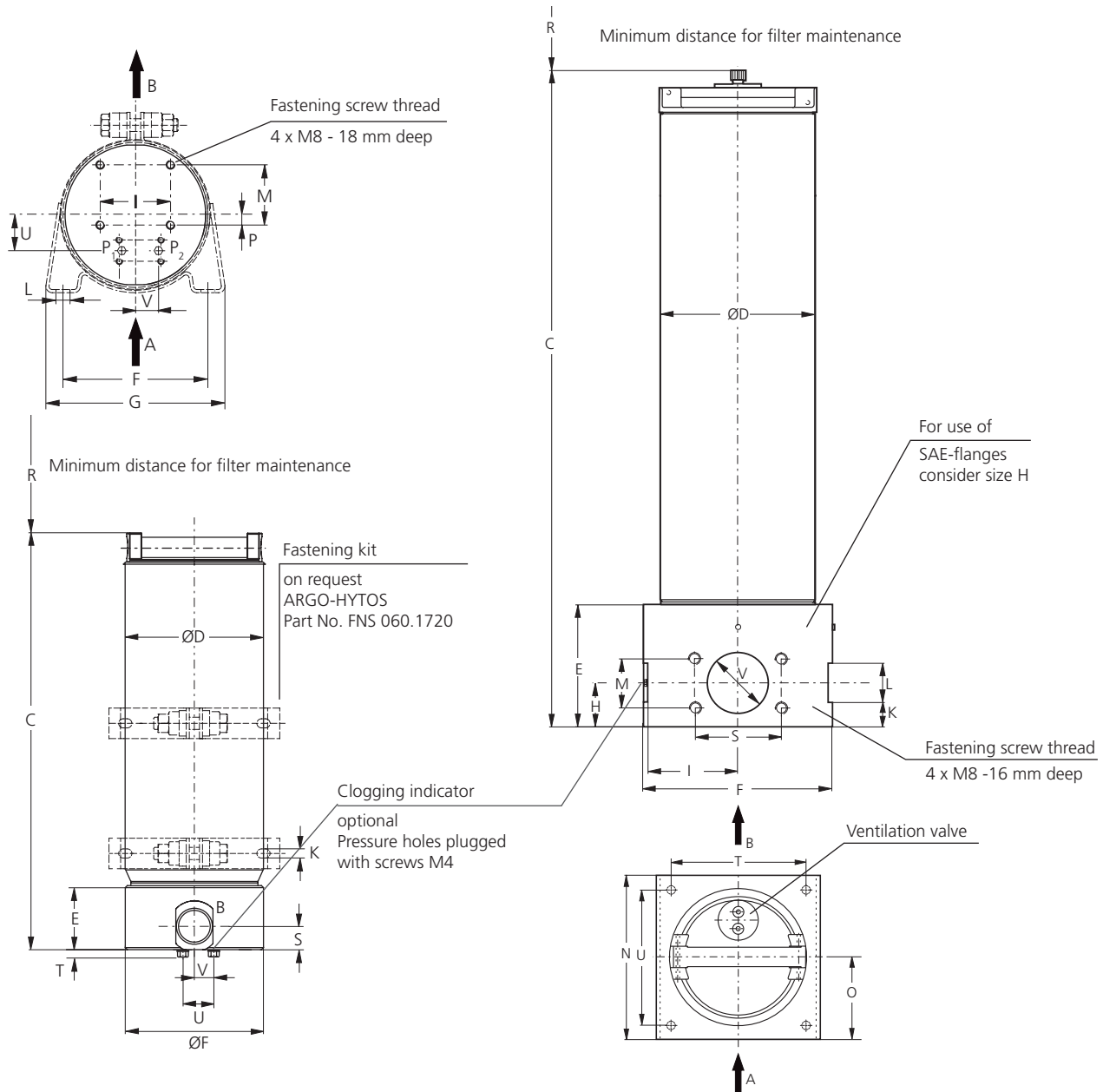

Measurements in mm

Type	A / B	C	D	E	F	G	H	I	K	L	M	N	O	P	R	S	T	U	V
FN 060	G1	410	140	63	136	170	-	66	9	12	56.5	-	-	9.5	300	23	4	34	21
FN 300	SAE 2½	775	160	126	200	-	45	96	25	40	50.8	195	97.5	-	700	88.9	170	165	63

Measurements in inch

Type	A / B	C	D	E	F	G	H	I	K	L	M	N	O	P	R	S	T	U	V
FN 060	G1	16.14	5.51	2.48	5.35	6.69	-	2.60	0.35	0.47	2.22	-	-	0.37	11.81	0.91	0.16	1.34	0.83
FN 300	SAE 2½	30.51	6.30	4.96	7.87	-	1.77	3.78	0.98	1.57	2.00	7.68	3.84	-	27.56	3.50	6.69	6.50	2.48

Symbol

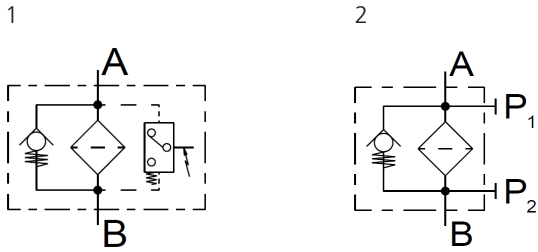

Quality Assurance

Quality management according to DIN EN ISO 9001

To ensure constant quality in production and operation, ARGO-HYTOS filter elements undergo strict controls and tests according to the following ISO standards:

- ISO 2941 Verification of collapse / burst pressure rating
- ISO 2942 Verification of fabrication integrity (Bubble Point Test)
- ISO 2943 Verification of material compatibility with fluids
- ISO 3968 Evaluation of pressure drop versus flow characteristics
- ISO 16889 Multi-Pass-Test (evaluation of filter fineness and dirt-holding capacity)
- ISO 23181 Determination of resistance to flow fatigue using high viscosity fluid

Various quality controls during the production process guarantee the leak-free function and solidity of our filters.

Illustrations may sometimes differ from the original. ARGO-HYTOS is not responsible for any unintentional mistake in this specification sheet.