

Off-line Filter Units**FNA1 008 / 016**

Operating pressure up to 4 bar / 58 psi · Nominal flow rate up to 19 l/min / 5.0 gpm



Off-line Filter Unit

Description**Application**

In the by-pass flow of hydraulic and lubrication systems.

Performance features*Protection against wear:*

By means of filter elements that meet the highest demands regarding cleanliness class and dirt-holding capacity.

Protection against failure:

By means of continuous partial filtration, excellent cleanliness classes can be achieved. Machine failures, due to contamination, are reduced, maintenance and oil change intervals are extended.

Special design features*Housing cover:*

The cover can be opened without special auxiliary tools.

Compact:

The unique cover design allows that the filter element can be changed without losing any oil. No pipes are needed except for the connection lines. The filter units feature low power consumption and minimal operational noise.

Pressure relief valve:

An integrated PRV (pressure relief valve) protects against overload.

Dirt retention valve:

At the bottom of the filter element, flow through from the inside to the outside, there is a dirt retention valve. This closes while pulling the filter element, which is hung up at the cover, out of the housing. Sedimented dirt is removed together with the filter element. Because of the cover design, the filter element change can be carried out almost without losing any oil.

Filter elements

Flow direction from the inside to the outside. The star-shaped pleating of the filter material results in:

- › large filter surfaces
- › low pressure drop
- › high dirt-holding capacities
- › particularly long maintenance intervals

Filter maintenance

By using a clogging indicator, the correct moment for maintenance is stated, what guarantees optimum utilization of the filter life.

Materials

Pump housing:	Aluminum alloy
Filter housing:	Steel
Cover:	Aluminum alloy
Seals:	NBR (FPM on request)
Filter media:	EXAPOR®MAX 2 - inorganic, multi-layer microfiber web

Accessories

With Part No. FNA 008.1700, a mounting set is available, that facilitates the fitting of incoming and outgoing pipes onto an existing filling / venting connection.

Electrical and / or optical clogging indicators may be ordered together with the off-line filter unit. For choosing the proper clogging indicator see table Clogging Indicator in the Ordering Code. A separate order of the clogging indicator is possible. For dimensions and technical data of the clogging indicators - see catalog sheet 60.30.

Hydraulic fittings and hoses for installation of the unit in the system are available on request.

For installation in filter cooling circuits, a version with by-pass valve is available on request.

Characteristics

Nominal flow rate

Up to 19 l/min at $v = 35 \text{ mm}^2/\text{s}$ /
up to 5 gpm at $v = 162 \text{ SUS}$

Viscosity range

15 - 250 mm^2/s / 70 - 1160 SUS - continuous operation
15 - 400 mm^2/s / 70 - 1860 SUS - short term operation

Off-line filter units for higher viscosities
(up to 1500 mm^2/s / 6950 SUS)
see catalog sheet FNA1HV 008 / 016 no. 80.41

Connection

Threaded port according to ISO 228
(see Ordering Code and Dimension Drawing)

Filter fineness

3 $\mu\text{m(c)}$... 10 $\mu\text{m(c)}$ for EXAPOR®MAX 2
separating solid particles
3 $\mu\text{m(c)}$... 7 $\mu\text{m(c)}$ for EXAPOR®AQUA
separating water and solid particles

Dirt-holding capacity

The dirt-holding capacity values in grams from the ISO MTD test dust are in accordance with the ISO 16889 requirements (see Ordering Code, table Filter Element).

Hydraulic fluids

Mineral oil and biodegradable fluids
(HEES and HETG, see info-sheet 00.20)

Temperature range of fluids

0 °C ... +65 °C / +32 °F ... +149 °F
(also see viscosity range)

Ambient temperature range

0 °C ... +50 °C / +32 °F ... +122 °F

Suction height

max. 1 m / 3.28 ft (unfilled)
max. 6 m / 19.69 ft (in operating condition)

Operating pressure

Max. 4 bar / 58 psi, pressure protection with pressure relief valve

Operating position

Vertical, motor at the bottom

Recommended tank capacities

FNA1 008: up to 800 l / 200 gal
FNA1 016: up to 1500 l / 400 gal

Off-line filter units for tank capacities exceeding
1500 l / 400 gal see catalog sheet FNA 045 no. 80.50.

Ordering code

Type of filter unit		Code	
Off-line filter unit		FNA1	

Nominal flow rate*		Code	
8 l/min / 2.11 gpm		008	
16 l/min / 4.23 gpm		016	

Connection port		Code	
Size	Dimensions type no.		
In: G $\frac{3}{4}$ Out: G $\frac{1}{2}$	1 or 2	G	
In: 1 $\frac{1}{16}$ -12 UN-2B Out: $\frac{3}{4}$ -16 UN-2B	3 or 4	U	

Filter element					Code	
		Fineness ($\beta=200$) Dirt-holding capacity according to ISO 16889 / water capacity		Filter element		
		FNA1 008	FNA1 016			
EXAPOR [®] MAX 2	3 μ m	490 g	280 g	V7.1220-113	V003	
EXAPOR [®] MAX 2	5 μ m	460 g	270 g	V7.1220-13	V005	
EXAPOR [®] MAX 2	10 μ m	340 g	190 g	V7.1220-06	V010	
EXAPOR [®] AQUA	7 μ m	64 g / 320 ml	38 g / 190 ml	Y7.1220-05	Y007	
EXAPOR [®] AQUA	3 μ m	45 g / 340 ml	25 g / 205 ml	Y7.1220-113	Y003	

Electric motor*					Code	
Phase(s), voltage	Frequency	Power FNA 1 008 / 016	Electric connection	Dimensions type no.		
3~400/460 VAC	50/60 Hz	0.25 / 0.45 kW	1	1 or 3	40050	
1~230 VAC	50/60 Hz	0.25 / 0.45 kW	2	2 or 4	23050	
1~110 VAC	50/60 Hz	0.25 / 0.45 kW	2	2 or 4	11050	

Clogging indicator						Code	
Type		Code of indicator	Data sheet no.	Connection	Hydraulic symbol		
Manometer	optical	DG 200-16	60.20	M12 x 1.5	1	O	
Pressure switch	electrical	DG 813-21	60.20	M12 x 1.5	2	E	
Pressure switch	optical / electrical	DG 815-12	60.20	M12 x 1.5	3	EO	
				M12 x 1.5	4	X	
Differential pressure clogging indicator	optical	DG 042-01	60.30	Flange	5	OD	
	electrical	DG 041-32	60.30	Flange	6	ED	
	electrical + optical	DG 041-32 + DG 041.1200	60.30	Flange	7	EOD	
				Flange	8	XD	

* Indications at 50 Hz. At 60 Hz, the value increases by approx. 20%.
For version with DC motor, 24 or 12 V see data sheet FNA 014 no. 80.35

Dimensions

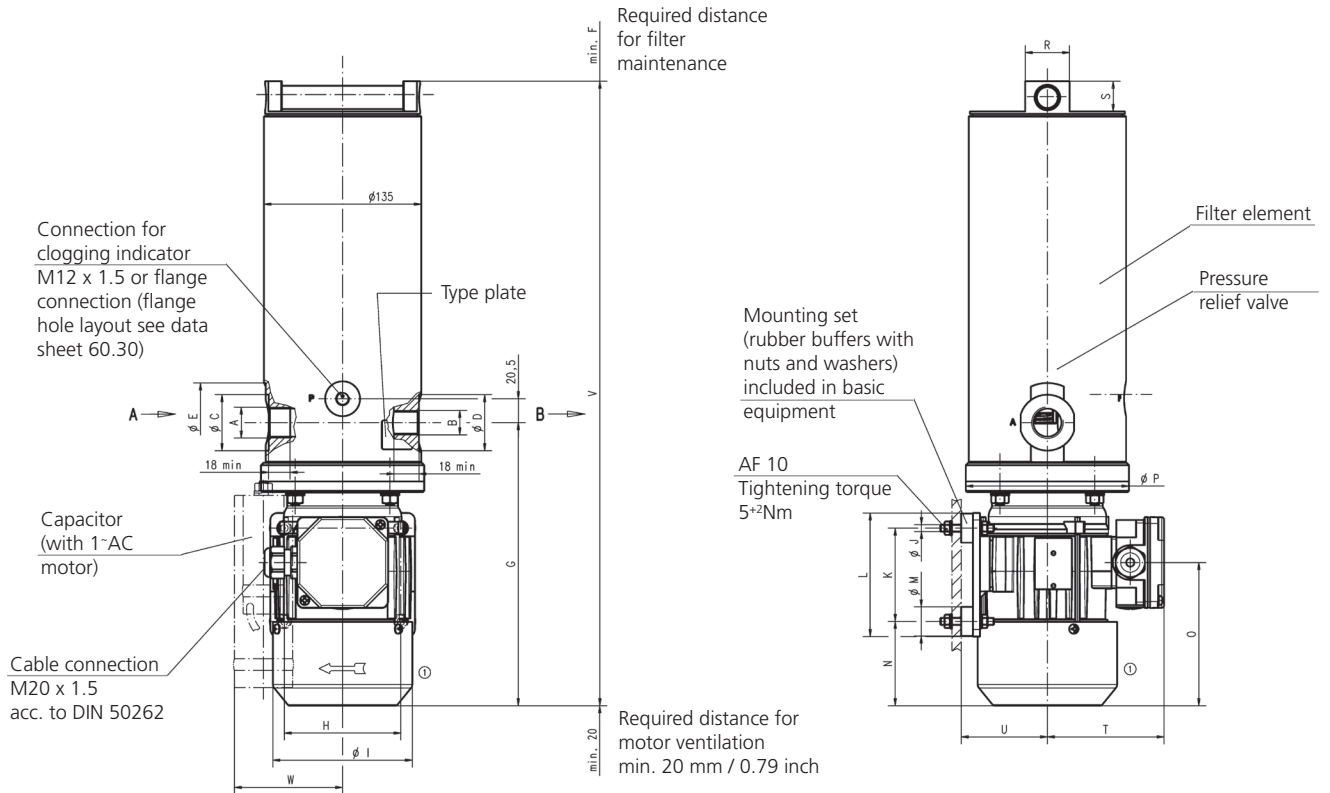

Measurements in mm

Type*	A	B	C	D	E	F	G	H	I	J	K	L	M
1	G ^{3/4}	G ^{1/2}	48	48	68	340	243	100	120	M6	80	106	25
2	G ^{3/4}	G ^{1/2}	48	48	68	340	243	100	120	M6	80	106	25
3	1 ^{1/16} -12 UN-2B	3/4-16 UNF-2B	41	30	68	340	243	100	120	M6	80	106	25
4	1 ^{1/16} -12 UN-2B	3/4-16 UNF-2B	41	30	68	340	243	100	120	M6	80	106	25

Type*	N	O	P	R	S	T	U	V	W				
1	72	123	140	38	26	101	74	535	-				
2	72	123	140	38	26	101	74	535	100				
3	72	123	140	38	26	101	74	535	-				
4	72	123	140	38	26	101	74	535	100				

Measurements in inch

Type*	A	B	C	D	E	F	G	H	I	J	K	L	M
1	G ^{3/4}	G ^{1/2}	1.89	1.89	2.68	13.39	9.57	3.94	4.72	M6	3.15	4.17	0.98
2	G ^{3/4}	G ^{1/2}	1.89	1.89	2.68	13.39	9.57	3.94	4.72	M6	3.15	4.17	0.98
3	1 ^{1/16} -12 UN-2B	3/4-16 UNF-2B	1.61	1.18	2.68	13.39	9.57	3.94	4.72	M6	3.15	4.17	0.98
4	1 ^{1/16} -12 UN-2B	3/4-16 UNF-2B	1.61	1.18	2.68	13.39	9.57	3.94	4.72	M6	3.15	4.17	0.98

Type*	N	O	P	R	S	T	U	V	W				
1	2.83	4.84	5.51	1.50	1.02	3.98	2.91	21.06	-				
2	2.83	4.84	5.51	1.50	1.02	3.98	2.91	21.06	3.94				
3	2.83	4.84	5.51	1.50	1.02	3.98	2.91	21.06	-				
4	2.83	4.84	5.51	1.50	1.02	3.98	2.91	21.06	3.94				

*Type see Ordering Code (Dimensions Type no.)

Hydraulic symbols

1

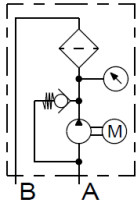

2

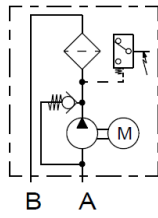

3

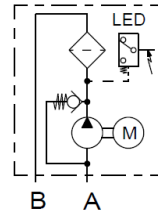

4

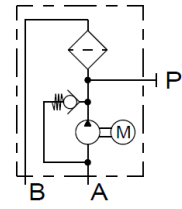

5

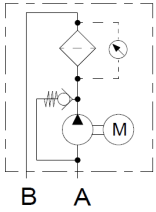

6

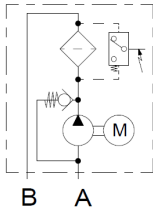

7

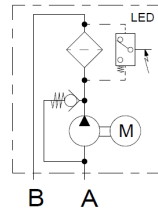

8

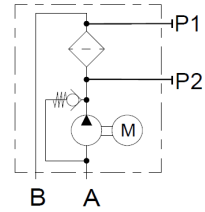

Electric connections

1

Delta connection

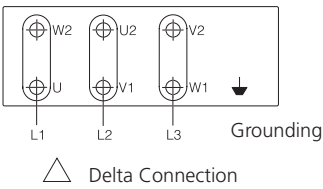

Star connection

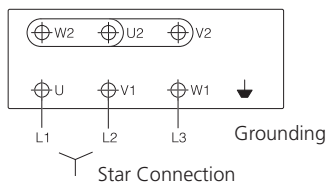

2

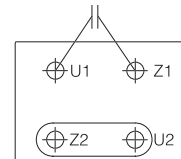

Order example

FNA1 016G-V003/23050-E

Off-line filter unit with nominal flow rate 16 l/min / 4.23 gpm, inlet port G $\frac{3}{4}$, outlet port G $\frac{1}{2}$, EXAPOR[®]MAX 2 filter element, fineness 3 μ m, electric motor 1~230 VAC and electric clogging indicator

Dimensions type: 2

Remarks:

Combinations listed in this data sheet are standard units. If modifications are required, we kindly ask for your request.

Illustrations may sometimes differ from the original. ARGO-HYTOS is not responsible for any unintentional mistake in this specification sheet.